



*Andscot Company, Inc.*

9117 MEDILL AVENUE, FRANKLIN PARK, ILLINOIS 60131

Phone: 847-455-5800

Fax: 847-455-5825

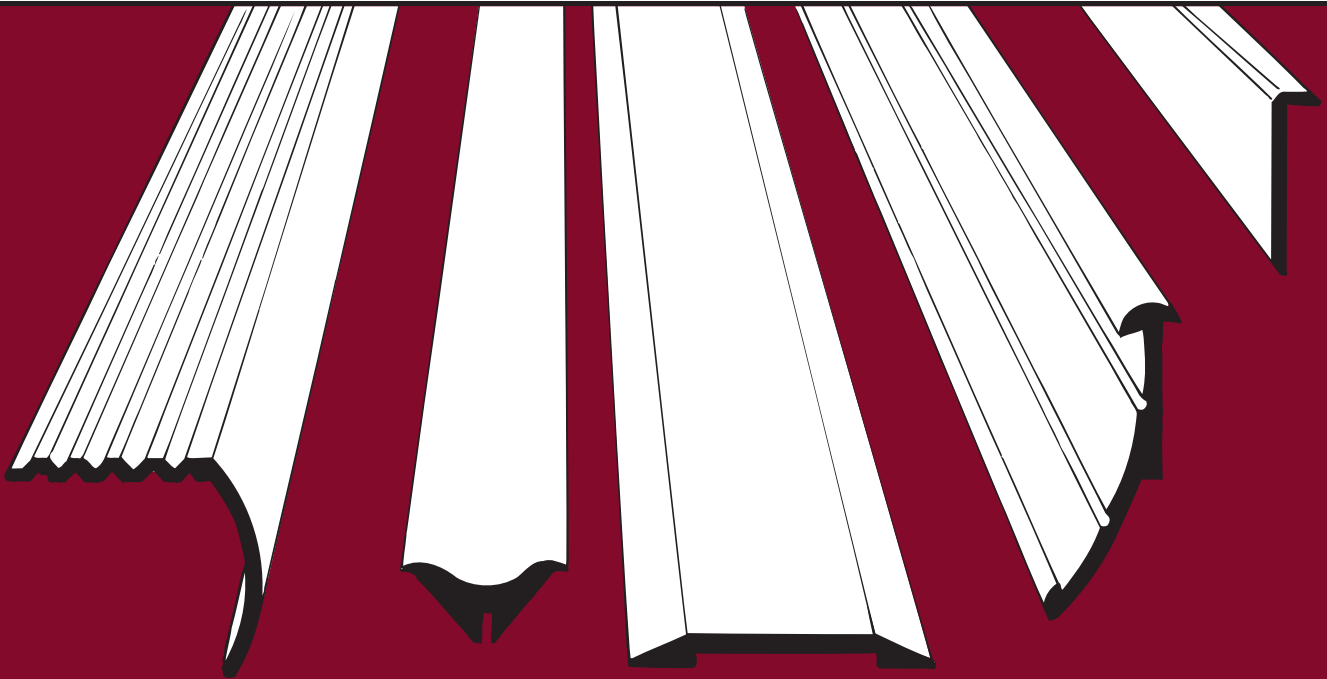

*Aluminum and Stainless Steel*

**MOULDINGS**

# General Information

The items ILLUSTRATED in this catalog are stock and available for shipment from ANDSCOT warehouse.

Unless otherwise noted, all ALUMINUM TRIMS are stocked with an Etched & Anodized Finish with STAINLESS STEEL TRIMS, a Brite Finish.

Material may not be returned for credit without prior written authorization from Andscot. Where returns are authorized and Andscot is not at fault, the credit allowed will be subject to a 15% re-stocking charge.

MINIMUM ORDER: Minimum order on a charge is \$20.00.

CUTTING TO LENGTH: Minimum cutting charge of \$15.00 with apply to all cut orders.

FREIGHT: All sales are F.O.B. Our Warehouse, unless otherwise quoted.

Orders under \$500.00 or 100 Pounds of material may be subject to a pallet charge

CLAIMS: Any shipment damaged or lost in transit is the responsibility of the carrier.

We are not responsible for damage, loss or delay after goods are picked up by the carrier. When there is a LOSS OR APPARENT VISIBLE DAMAGE to a shipment revealed, DO NOT give the carrier a clear receipt.

Note such damage on the carrier's delivery receipt and HAVE THE DRIVER SIGN THE RECEIPT. DO NOT REFUSE DELIVERY. REFUSAL OF DELIVERY WILL DELAY THE CLAIMS PROCESS AND SHIPMENT OF REPLACEMENT MATERIAL

CONCEALED DAMAGE OR LOSS: Please follow these instructions in the event of CONCEALED DAMAGE OR LOSS.

1. Advise the delivering carrier in writing no more than 15 days after the delivery. and request the carrier to make an inspection.
2. RETAIN THE CONTAINER and ALL PACKING MATERIAL of the damaged or lost material that was shipped in for the carrier's inspection.
3. SHORTAGES must be reported to us within 15 days after receipt of goods.

## INDEX TO CONTENTS

| TYPE OF TRIM                       | PAGE | TYPE OF TRIM                               | PAGE |
|------------------------------------|------|--|------|
| Nosings and Caps                   | 1    | Mirror Edge Sealer, Clips & Mirror Mastic  | 12   |
| Wallboard & Trim Mouldings         | 2-6  | Mirror Plates                              | 13   |
| Marine Metals & Facings            | 7-9  | Foam Mounting Tapes                        | 14   |
| Stairnosings, Binders & Door Track | 9    | Glass Cleaner, Stainless Angles & Channels | 15   |
| Mirror and Glass Trims             | 10   | Industrial Metals                          | 16   |



**NOSINGS APPLIED-AFTER**

**EXTRUDED ALUMINUM MOULDINGS - BUFFED AND CLEAR FINISH**

**NOSINGS ARE PRE DRILLED AND COUNTERSUNK #4**

**OVALHEAD**

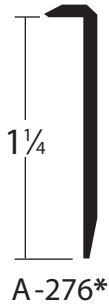
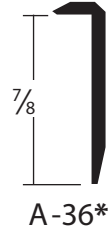
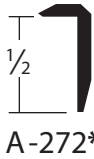

**CAP MOULDINGS**

**EXTRUDED ALUMINUM MOULDINGS - BUFFED AND CLEAR FINISH**

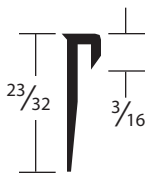

A-604L  
1/16" MAT'L  
MFA



A-604S\*  
3/32" MAT'L  
MFA

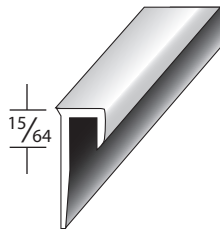

A-604H\*  
1/8" MAT'L  
MFA

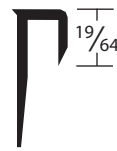

A-604-WB\*  
5/32" MAT'L

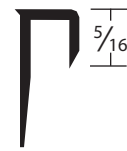

A-604-3\*  
3/16" MAT'L

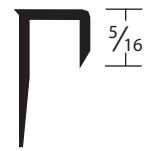

A-604-4\*  
1/4" MAT'L

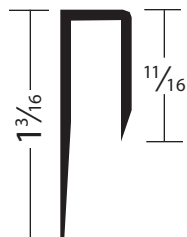

ACI-15  
FOR 5/16" MAT'L

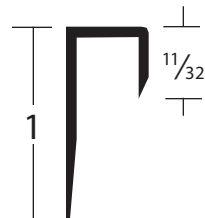

ACI-21  
FOR 5/16" MAT'L

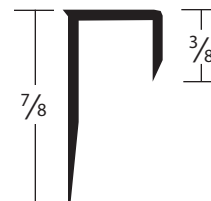

A604-6\*  
3/8" MAT'L

\* Non-Stock Specials. Available on Minimum Order Only.

See Sections Listed Above with the Minimum Amount Required



## WALLBOARD & TRIM MOULDINGS

|                         | ITEM#  | Description  | Finish | LGTH | PCK | WT |
|-------------------------|--------|--|--------|------|-----|----|
| <p><b>DIE 2334*</b></p> | 410800 | 1/16" Cap TM80 (A604-L)  | MFA    | 12'  | 40  | 24 |
| <p><b>DIE 0204*</b></p> | 410805 | 1/16" Flat Back TM81   | MFA    | 12'  | 40  | 26 |
| <p><b>DIE 4533*</b></p> | 410820 | 1/16" Deep Slot Cap TM84                                       | MFA    | 12'  | 40  | 26 |
| <p><b>DIE 0214*</b></p> | 410810 | 3/32" Wide Face TM82   | MFA    | 12'  | 40  | 28 |
| <p><b>DIE 2314*</b></p> | 410815 | 3/32" Cap TM83   | MFA    | 12'  | 40  | 26 |
| <p><b>DIE 7441*</b></p> | 409130 | <b>Punched and Slotted</b><br>3/32" Coving Cap CM901 (A-604-H) | MFA    | 8'   | 60  | 30 |

**\* Non-Stock Specials. Available on Minimum Order Only.  
See Sections Listed Above with the Minimum Amount Required**



**WALLBOARD & TRIM MOULDINGS**

ITEM# Description Finish LGTH PCK WT

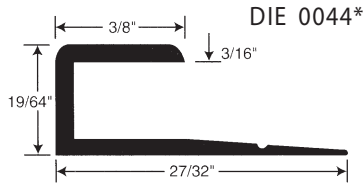

410720 3/16" Cap TM72 BA 8' 80 28

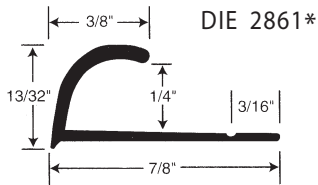

404049 1/4" Coving Cap CM400 HMF 12' 40 44  
 404050 1/4" Coving Cap CM400 HB 12' 40 44

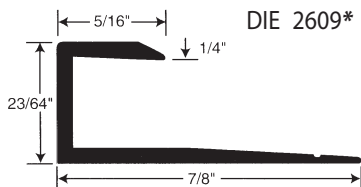

404101 1/4" Coving Cap CM401 (A-604-4) BA 12' 40 40

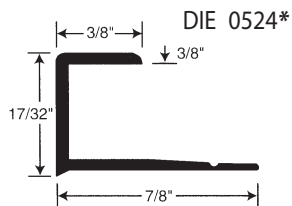

334190 3/8" Cap (A-604-6) BA 12' 12 18

\* Non-Stock Specials. Available on Minimum Order Only.  
 See Sections Listed Above with the Minimum Amount Required



**WALLBOARD & TRIM MOULDINGS**

|                  | ITEM#  | Description              | Finish | LGTH | PCK | WT |
|------------------|--------|--------------------------|--------|------|-----|----|
| <p>DIE 0326*</p> | 410520 | 13/16" Offset Drill TM52 | BA     | 12'  | 40  | 37 |
| <p>DIE 0106*</p> | 410585 | 3/32" Cove TM85          | BA     | 12'  | 40  | 41 |
| <p>DIE 0126*</p> | 410900 | 1/16" Cove TM90          | BA     | 12'  | 40  | 44 |
| <p>DIE 0265*</p> | 410905 | 1/16" Cove TM91          | BA     | 12'  | 40  | 30 |
|                  | 410906 | 1/16" Cove TM91          | BB     | 12'  | 40  | 30 |
| <p>DIE 0426*</p> | 410910 | 1/16" Cove TM92          | BA     | 12'  | 40  | 24 |
|                  | 410911 | 1/16" Cove TM92          | BB     | 12'  | 40  | 24 |
| <p>DIE 5755*</p> | 410935 | 1/16" Cove TM98          | BA     | 12'  | 40  | 35 |

\* Non-Stock Specials. Available on Minimum Order Only.

See Sections Listed Above with the Minimum Amount Required



**WALLBOARD & TRIM MOULDINGS**

| ITEM# | Description | Finish | LGTH | PCK | WT |
|-------|-------------|--------|------|-----|----|
|-------|-------------|--------|------|-----|----|

**DIE 0021\***

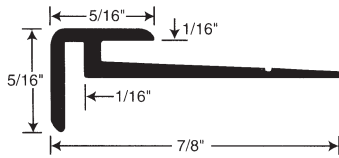

|        |                    |    |     |    |    |
|--------|--------------------|----|-----|----|----|
| 410915 | 3/64" Outside TM93 | BA | 12' | 40 | 41 |
|--------|--------------------|----|-----|----|----|



**WALLBOARD & TRIM MOULDINGS**

ITEM# Description Finish LGTH PCK WT

DIE 5044\*

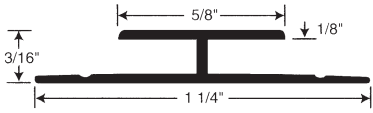

442057 3/32" Division WB110 EA 8' 50 44

DIE 0023\*

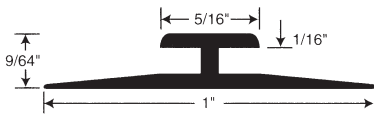

410920 .050 Division TM94 BA 12' 40 36

DIE 2413\*

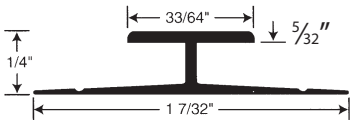

442050 1/8" Division WB103 BA 8' 100 88

DIE 2611\*

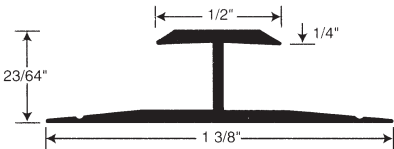

443010 1/4" Division WB303 BA 8' 100 85

\* Non-Stock Specials. Available on Minimum Order Only.

See Sections Listed Above with the Minimum Amount Required





**MARINE METALS & FACINGS**

|  | DIE   | ITEM#  | Description   | Finish | LGTH | PCK | WT |
|--|-------|--------|---|--------|------|-----|----|
|  | 1880* | 360390 | Gutter 1<br>Countersunk for #6 fasteners<br>on 6" centers                   | BDMAC  | 12'  | 12  | 32 |
|  | 1010* | 360116 | Oval 3/4" x 3/16" (A-195)<br>Countersunk for #6" fasteners<br>on 6" centers | BMAC   | 12'  | 12  | 20 |
|  | 1666* | 360250 | Oval 1" x 3/16" (A-197)<br>Countersunk for #6 fasteners<br>on 6" centers    | BMAC   | 12'  | 12  | 23 |
|  | 0508* | 410210 | Plain facing 3/4" TM21 (A-275)<br>Countersunk for #4 oval head              | BA     | 12'  | 40  | 35 |
|  | 0538* | 410230 | Plain facing 7/8" TM23 (A-36)<br>Countersunk for #4 oval head               | BA     | 12'  | 40  | 40 |
|  | 0558* | 410250 | Plain facing 1 1/16" TM25 (A-24)<br>Countersunk for #4 oval head            | BA     | 12'  | 40  | 47 |

\* Non-Stock Specials. Available on Minimum Order Only.  
See Sections Listed Above with the Minimum Amount Required



**MARINE METALS & FACINGS**

|       | <b>DIE 0598*</b> | <b>ITEM#</b>   | <b>Description</b> | <b>Finish</b> | <b>LGTH</b> | <b>PCK</b> | <b>WT</b> |
|-------|------------------|--|--------------------|---------------|-------------|------------|-----------|
|       | 410240           | Plain facing 1 1/4" TM24 (A-276)<br>Countersunk for #4 oval head   | BA                 | 12'           | 40          | 59         |           |
| <hr/> |                  |  |                    |               |             |            |           |
|       | <b>DIE 0578*</b> |  |                    |               |             |            |           |
|       | 410195           | Plain facing 1/2" TM19 (A-272)<br>Countersunk for #4 oval head     | BA                 | 12'           | 40          | 27         |           |
| <hr/> |                  |  |                    |               |             |            |           |
|       | <b>DIE 0938*</b> |  |                    |               |             |            |           |
|       | 360860           | Plain facing 7/8"<br>Countersunk for #6 fasteners<br>on 6" centers | BMAC               | 12'           | 12          | 18         |           |
| <hr/> |                  |  |                    |               |             |            |           |
|       | <b>DIE 0937*</b> |  |                    |               |             |            |           |
|       | 360515           | Plain facing<br>Countersunk for #6 fasteners<br>on 6" centers      | BMAC               | 12'           | 12          | 11         |           |
| <hr/> |                  |  |                    |               |             |            |           |
|       | <b>DIE 0838*</b> |  |                    |               |             |            |           |
|       | 410310           | Insert facing 7/8" TM31<br>Countersunk for #4 Flat head            | BA                 | 12'           | 40          | 39         |           |

**\* Non-Stock Specials. Available on Minimum Order Only.**

**See Sections Listed Above with the Minimum Amount Required**



**MARINE METALS & FACINGS**

|  | DIE 0395* | ITEM#  | Description | Finish | LGTH | PCK | WT |
|--|-----------|--------|-------------|--------|------|-----|----|
|  |           | 333690 | 1" Tee      | BA     | 12'  | 12  | 20 |

|  | DIE 0365* | ITEM#  | Description | Finish | LGTH | PCK | WT |
|--|-----------|--------|-------------|--------|------|-----|----|
|  |           | 333600 | 3/4" Tee    | BA     | 12'  | 12  | 16 |

**STAIR NOSINGS** EXTRUDED ALUMINUM - APPLIED AFTER DESIGN

Stocked in 12' Lengths

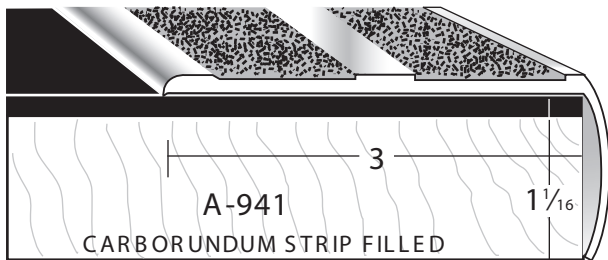

Stocked in 12' EA

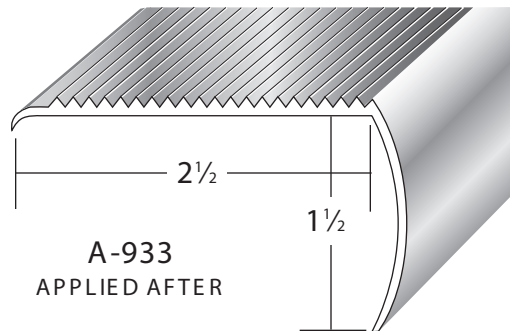

\* Non-Stock Specials. Available on Minimum Order Only.  
See Sections Listed Above with the Minimum Amount Required



**MIRROR & GLASS MOULDINGS**

**"J" MOULDINGS**

ALUMINUM – ANODIZED FINISH

STOCKED IN BRITE & GOLD

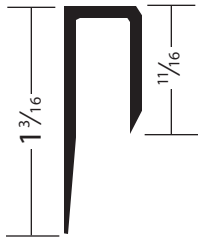

**ACI-15**  
5/16" OPENING  
Stocked in Brite,  
Brushed Nickel, Matte  
Black, Polished Black,  
BREA & Oil Rub Bronze

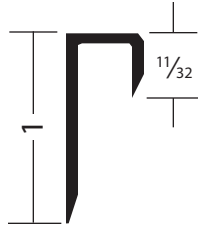

**ACI-21**  
5/16" OPENING  
Stocked in Brite,  
Brushed Nickel, BREA,  
Polished Black Matte  
Black & Oil Rub  
Bronze

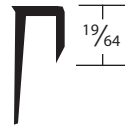

**A-604-WB\***  
5/32" OPENING  
Stocked Silver

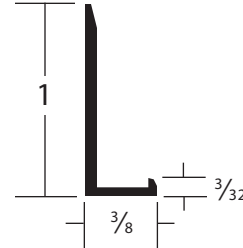

**ACI 51**  
LITTLE LIP  
Stocked in Brite

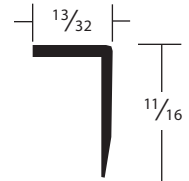

**ACI 30**  
END CAP  
Stocked in Brite

Actual Sizes

ALL "J" TRIMS STOCKED 12 FT. AND SUPPLIED WITH PUNCHED AND SLOTTED BACK FLANGES

ALUMINUM – POLISHED & ANODIZED FINISH



**L BAR**  
**ACI-26**  
Size 1" x 5/16"  
Punched & slotted  
back flange  
Stocked in Brite

ALUMINUM

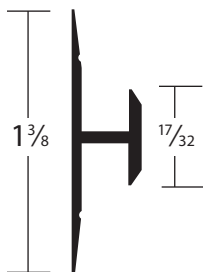

**DIVIDER**  
**1021-4\***  
1/4" OPENING  
Available Brite,



**CLOSURE STRIP**  
**ACI-29**  
Stocked in Brite  
and Brushed Nickel

\* Non-Stock Specials. Available on Minimum Order Only.  
See Sections Listed Above with the Minimum Amount Required

# Andscot

## Fast Grab Mirror Mastic

**Instantly Grabs Mirrors While Adhesive Cures  
Bonds To All Types of Mirrors  
Strong Permanent Bond Which Remains Flexible**

- Does Not Sag, Will Not Shrink
- Solvent Free Formulation, Easy & Safe to Use
- Easy To Dispense, Remains Consistent, Low Odor
- Can Be Compressed To 1/32" Or Build Out To 2"

### MEETS AND EXCEEDS

- Conforms to OTC Rule for Adhesive
- Conforms to California Proposition 65
- Meets USDA Requirements For Non-Food Contact
- Meets Requirements of CARB & SCAQMD



10 fl. oz. Cartridge

New Fast Grab Mirror Mastic:  
This is a technologically advanced, environmentally safe adhesive for installing all types of mirrors. Hybrid/Urethane formulation provides installers with a solvent free adhesive, that's fast grabbing, easy to use and provides a strong permanently flexible bond.

## PROVEN BEST! GUNTHER MIRROR MASTICS

### ULTRA/BOND™



Two time tested superior bonding mirror mastics designed for durable, quality installations.

- Ultra/Bond gives the ultimate in convenient drying and strength. It can be gunned from cartridges at a wide variety of temperatures, cutting waste while saving time. A unique formulation gives ultimate bonding while remaining flexible for structural and temperature changes over the life of the installation.



## PROVEN BEST! GUNTHER MIRROR & MORE CLEANER™

A Superior  
Glass and Mirror  
All-purpose Cleaner



TESTED AND  
APPROVED FOR MIRRORS.

A superior mirror and glass all-purpose cleaner. Discover the wonders of this ammonia and vinegar free cleaner. Dissolves dirt, grease and most deposits. Leaves no film and cleans streak-free. Cleans glass, porcelain, tile, chrome, stainless steel, marble and appliances sparkling clean. You'll find it very useful for most cleaning jobs.

UNIQUE 5-GALLON  
BAG-IN-A-BOX  
DISPOSABLE CONTAINER.

Economical bulk container. Stackable, convenient to ship, takes less storage space than other containers and is easy to handle.



## GLASS OR ACRYLIC MIRROR PLATES

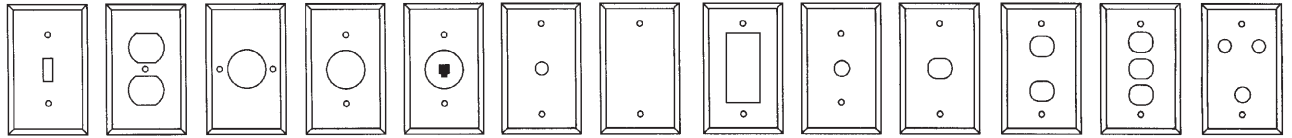

**A-1** Single TOGGLE  
**B-5** Single DUPLEX  
**D-8** Single PHONE (1-3/8" Hole)  
**D-9** Single PHONE (1-3/8" Hole)  
**MT-1** Modular PHONE With Wiring  
**D-10** Single T.V. (3/8" Hole)  
**D-11** Single BLANK  
**102** Single DECORA  
**104** Single DIMMER  
**106** Single 1 HOLE DESPARD  
**107** Single 2 HOLE DESPARD  
**108** Single 3 HOLE DESPARD  
**109** Single ALARM (3/8" hole)

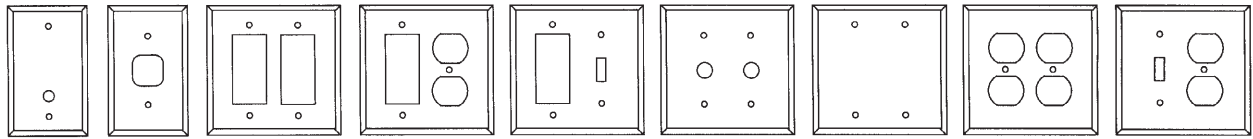

**111** Single T.V.OFFSET (3/8") Hole  
**112** Single PHONE (Square)  
**202** Double DECORA  
**205** DECORA DUPLEX  
**206** DECORA TOGGLE  
**207** DOUBLE DIMMER  
**208** DOUBLE BLANK  
**B-6** DOUBLE DUPLEX  
**C-7** SWITCH DUPLEX

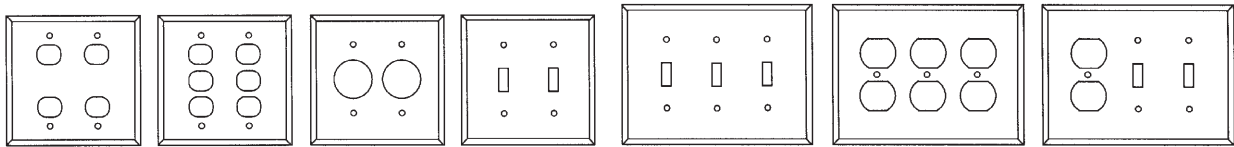

**209** 4 HOLE DESPARD  
**210** 6 HOLE DESPARD  
**211** DOUBLE PHONE (1-3/8" Hole)  
**A-2** DOUBLE TOGGLE  
**A-3**  
**B-3**  
**C-8**

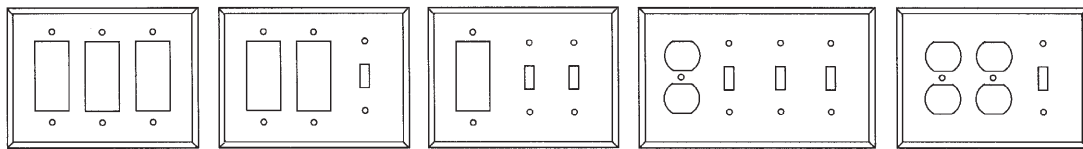

**302** **305** **306** **C-9** **C-10**

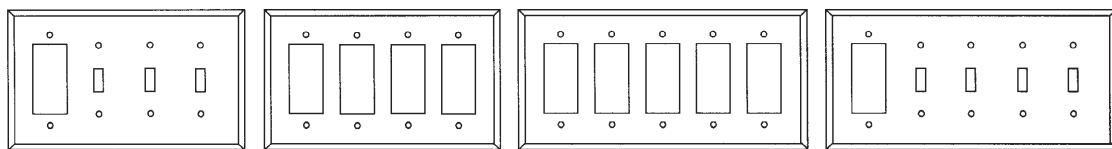

**406** **402** **502** **506**

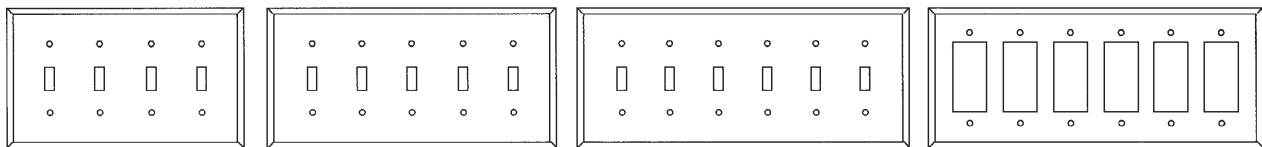

**A-4** **A-5** **A-6** **602**

**SUPER SIZE PLATES ARE AVAILABLE IN 1/8" CLEAR OR BRONZE WITH NO GASKET OR 1/4" CLEAR OR BRONZE WITH GASKET - IN SINGLE, DOUBLE, TRIPLE, 4-GANG, 5-GANG AND 6-GANG.**

**\* Non-Stock Specials. Available on Minimum Order Only.  
 See Sections Listed Above with the Minimum Amount Required**



## **ANDSCOT QUALITY FOAM MOUNTING TAPES FOR USE WITH ALL MIRROR PRODUCTS**

- As a shim the tape keeps butted mirror edges on the same plane for straight reflection lines.
- Tape can be folded easily to create needed thickness.
- Firmly secures mirror to painted or unpainted metal bifold doors.
- Mounts beveled mirror overlays onto mirrored wall.
- A must when attaching aluminum extrusions to glass for shower doors.
- Acts as a gasket between glass to glass portions of glass furniture.
- Tape will not be affected by mastic used bond mirror to wall.

Our foam tape has been tested by mirror manufacturers and is chemically compatible with all coatings including UV cured and lead-free mirror paint backings. It will not corrode the mirror backing or cause ghosting.

### **Provides production flexibility**

- Tape can be applied to either surface first.
- Safe - Our cured, pressure sensitive adhesive is safe for workers to handle and is environmentally sound.
- The paper liner is biodegradable.
- Consistent performance is engineered into all our tapes - Adhesive mass is the same every time.

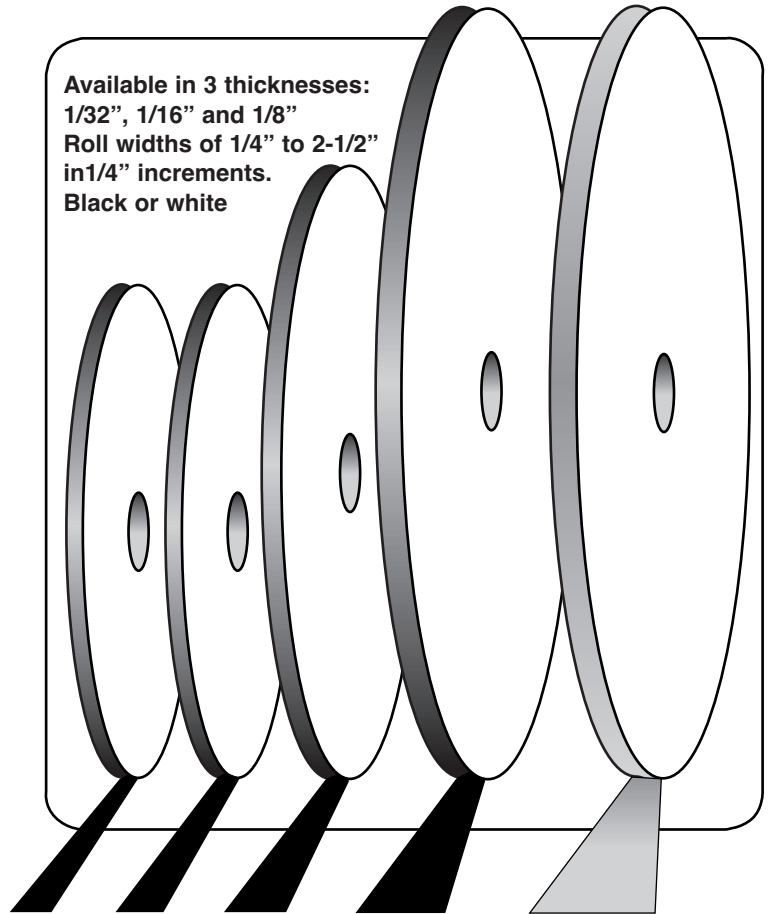

| WHEN TO USE...  | RUBBER | OR | ACRYLIC                               |
|---|--------|----|---------------------------------------|
| <b>Bifold Doors</b>   | X      |    |                                       |
| <b>Shower Enclosures</b>  | X      |    |                                       |
| <b>Beveled Overlays</b>   | X      |    | X<br>Acrylic allows for repositioning |
| <b>Shims For Seam Reflection Lines</b>                          | X      |    |                                       |
| <b>High Temperature</b><br>(Environment over 100°F. continuous) |        |    | X                                     |



**INDUSTRIAL METALS**

|                  | ITEM#  | Description                   | Finish | LGTH | PCK | WT |
|------------------|--------|-------------------------------|--------|------|-----|----|
| <p>DIE 0439*</p> | 306321 | Flatbar 1" x 1/16"            | EA     | 12'  | 6   | 8  |
| <p>DIE 1005</p>  | 300030 | Flatbar 1/2" x 1/8" (A-811)   | EA     | 12'  | 6   | 8  |
| <p>DIE 1048</p>  | 300220 | Flatbar 3/4" x 1/8" (A-812)   | EA     | 12'  | 6   | 9  |
| <p>DIE 1004</p>  | 300020 | Flatbar 1" x 1/8" (A-808)     | EA     | 12'  | 6   | 14 |
| <p>DIE 1068*</p> | 300306 | Flatbar 1 1/4" x 1/8"         | EA     | 12'  | 6   | 15 |
| <p>DIE 1049</p>  | 300228 | Flatbar 1 1/2" x 1/8" (A-796) | EA     | 12'  | 6   | 18 |

\* Non-Stock Specials. Available on Minimum Order Only.

See Sections Listed Above with the Minimum Amount Required





**INDUSTRIAL METALS**

|                         | <b>ITEM#</b> | <b>Description</b>           | <b>Finish</b> | <b>LGTH</b> | <b>PCK</b> | <b>WT</b> |
|-------------------------|--------------|------------------------------|---------------|-------------|------------|-----------|
| <p><b>DIE 1285</b></p>  | 300895       | Channel 5/16" x 3/8" (A-236) | EA            | 12'         | 6          | 6         |
| <p><b>DIE 1362*</b></p> | 301201       | Channel 5/16" x 1/2"         | EA            | 12'         | 6          | 11        |
| <p><b>DIE 2161</b></p>  | 303751       | Channel 5/16" x 3/4" (A-734) | EA            | 12'         | 6          | 12        |
| <p><b>DIE 1347</b></p>  | 301151       | Channel 7/16" x 1/4" (A-235) | EA            | 12'         | 6          | 10        |
| <p><b>DIE 1346</b></p>  | 301143       | Channel 9/16" x 1/2" (A-244) | EA            | 12'         | 6          | 10        |
| <p><b>DIE 2223*</b></p> | 304001       | Channel 13/16" x 1/4"        | EA            | 12'         | 6          | 10        |
| <p><b>DIE 1038*</b></p> | 300178       | Channel 1/2" x 5/16"         | EA            | 12'         | 6          | 12        |

**\* Non-Stock Specials. Available on Minimum Order Only.  
See Sections Listed Above with the Minimum Amount Required**



**INDUSTRIAL METALS**

ITEM# Description Finish LGTH PCK WT

DIE 1040\*

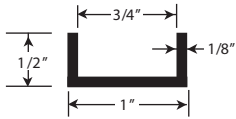

300187 Channel 1/2" x 3/4" EA 12' 6 20

DIE 1538\*

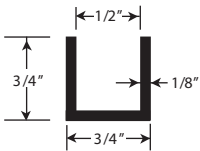

301901 Channel 3/4" x 1/2" EA 12' 6 22

DIE 1710\*

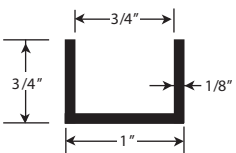

302501 Channel 3/4" x 3/4" EA 12' 6 26

DIE 1041\*

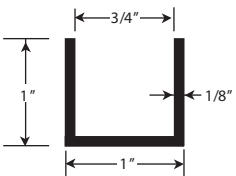

300191 Channel 1" x 3/4" EA 12' 6 32

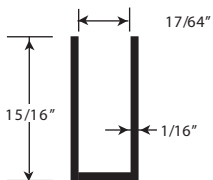

A-237\* Channel 7/8" x 17/64" EA 12' 6

\* Non-Stock Specials. Available on Minimum Order Only.

See Sections Listed Above with the Minimum Amount Required



**INDUSTRIAL METALS**

|                         | <i>ITEM#</i> | <i>Description</i>              | <i>Finish</i> | <i>LGTH</i> | <i>PCK</i> | <i>WT</i> |
|-------------------------|--------------|---------------------------------|---------------|-------------|------------|-----------|
| <p><b>DIE 1225*</b></p> | 300651       | Angle 3/4" x 1/2"               | EA            | 12'         | 6          | 6         |
| <p><b>DIE 1750*</b></p> | 302651       | Angle 3/4" x 3/8"               | EA            | 12'         | 6          | 10        |
| <p><b>DIE 1033*</b></p> | 300158       | Angle 1" x 1/2"                 | EA            | 12'         | 6          | 12        |
| <p><b>DIE 1249*</b></p> | 300751       | Angle 2 1/8" x 1"               | EA            | 12'         | 6          | 34        |
| <p><b>DIE 0141</b></p>  | 306001       | Equal Angle 1/2" x 1/2" (A-103) | EA            | 12'         | 6          | 6         |

**\* Non-Stock Specials. Available on Minimum Order Only.  
See Sections Listed Above with the Minimum Amount Required**



**INDUSTRIAL METALS**

|  | <b>DIE 0151</b> | <b>ITEM#</b> | <b>Description</b>                   | <b>Finish</b> | <b>LGTH</b> | <b>PCK</b> | <b>WT</b> |
|--|-----------------|--------------|--------------------------------------|---------------|-------------|------------|-----------|
|  |                 | 306051       | Equal Angle 3/4" x 3/4" (A-803)      | EA            | 12'         | 6          | 8         |
|  |                 | 306101       | Equal Angle 1" x 1" (A-903)          | EA            | 12'         | 6          | 12        |
|  |                 | 300083       | Equal Angle 3/4" x 3/4" (A-1185)     | EA            | 12'         | 6          | 16        |
|  |                 | 300091       | Equal Angle 1" x 1" (A-1187)         | EA            | 12'         | 6          | 22        |
|  |                 | 300110       | Equal Angle 1 1/2" x 1 1/2" (A-1163) | EA            | 12'         | 6          | 32        |
|  |                 | 300450       | Equal Angle 2" x 2" (A-1202)         | EA            | 12'         | 6          | 44        |

**\* Non-Stock Specials. Available on Minimum Order Only.  
See Sections Listed Above with the Minimum Amount Required**



**INDUSTRIAL METALS**

| ITEM# | Description | Finish | LGTH | PCK | WT |
|-------|-------------|--------|------|-----|----|
|-------|-------------|--------|------|-----|----|

DIE 1447\*

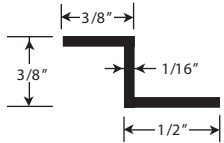

|        |                          |    |     |    |    |
|--------|--------------------------|----|-----|----|----|
| 331350 | Z Bar 3/8" x 1/2" x 3/8" | MF | 12' | 12 | 18 |
|--------|--------------------------|----|-----|----|----|

DIE 0569\*

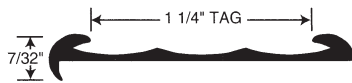

|        |                                 |    |     |    |    |
|--------|---------------------------------|----|-----|----|----|
| 331940 | Conventional Molding 1 1/4" tag | BA | 12' | 12 | 20 |
|--------|---------------------------------|----|-----|----|----|

DIE 1356\*

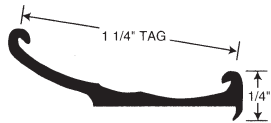

|        |   |    |     |    |    |
|--------|---|----|-----|----|----|
| 331260 | Standard Concave Molding<br>1 1/4" tag x 1/4" | BA | 12' | 12 | 23 |
|--------|---|----|-----|----|----|