



Andscot Company, Inc.

9117 MEDILL AVENUE, FRANKLIN PARK, ILLINOIS 60131

Phone: 847-455-5800

Fax: 847-455-5825

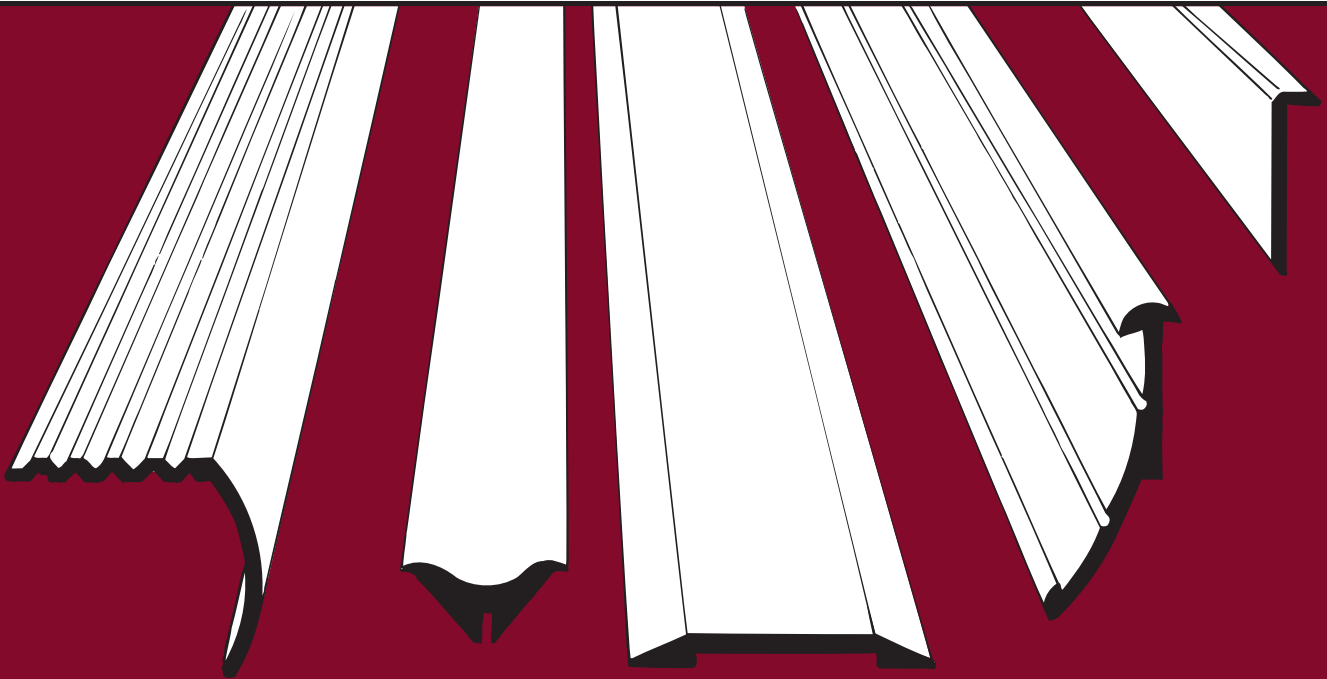

Aluminum and Stainless Steel

MOULDINGS

General Information

The items ILLUSTRATED in this catalog are stock and available for shipment from ANDSCOT warehouse.

Unless otherwise noted, all ALUMINUM TRIMS are stocked with an Etched & Anodized Finish with STAINLESS STEEL TRIMS, a Brite Finish.

Material may not be returned for credit without prior written authorization from Andscot. Where returns are authorized and Andscot is not at fault, the credit allowed will be subject to a 15% re-stocking charge.

MINIMUM ORDER: Minimum order on a charge is \$20.00.

CUTTING TO LENGTH: Minimum cutting charge of \$15.00 with apply to all cut orders.

FREIGHT: All sales are F.O.B. Our Warehouse, unless otherwise quoted.

Orders under \$500.00 or 100 Pounds of material may be subject to a pallet charge

CLAIMS: Any shipment damaged or lost in transit is the responsibility of the carrier.

We are not responsible for damage, loss or delay after goods are picked up by the carrier. When there is a LOSS OR APPARENT VISIBLE DAMAGE to a shipment revealed, DO NOT give the carrier a clear receipt.

Note such damage on the carrier's delivery receipt and HAVE THE DRIVER SIGN THE RECEIPT. DO NOT REFUSE DELIVERY. REFUSAL OF DELIVERY WILL DELAY THE CLAIMS PROCESS AND SHIPMENT OF REPLACEMENT MATERIAL

CONCEALED DAMAGE OR LOSS: Please follow these instructions in the event of CONCEALED DAMAGE OR LOSS.

1. Advise the delivering carrier in writing no more than 15 days after the delivery. and request the carrier to make an inspection.
2. RETAIN THE CONTAINER and ALL PACKING MATERIAL of the damaged or lost material that was shipped in for the carrier's inspection.
3. SHORTAGES must be reported to us within 15 days after receipt of goods.

INDEX TO CONTENTS

TYPE OF TRIM	PAGE	TYPE OF TRIM	PAGE
Nosings and Caps	1	Mirror Edge Sealer, Clips & Mirror Mastic	12
Wallboard & Trim Mouldings	2-6	Mirror Plates	13
Marine Metals & Facings	7-9	Foam Mounting Tapes	14
Stairnosings, Binders & Door Track	9	Glass Cleaner, Stainless Angles & Channels	15
Mirror and Glass Trims	10	Industrial Metals	16
Aluminum Track Assembly & Pulls	11		



NOSINGS APPLIED-AFTER
EXTRUDED ALUMINUM MOULDINGS - BUFFED AND CLEAR FINISH

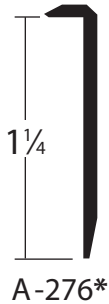
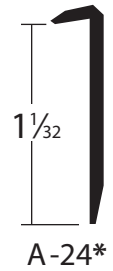
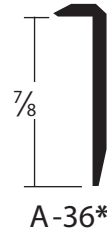
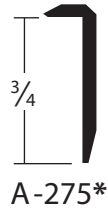
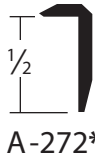

CAP MOULDINGS

EXTRUDED ALUMINUM MOULDINGS - BUFFED AND CLEAR FINISH

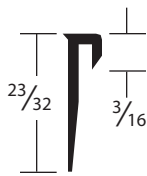

A-604L
 1/16" MAT'L
 MFA



A-604S*
 3/32" MAT'L
 MFA

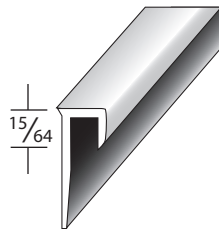

A-604H*
 1/8" MAT'L
 MFA



A-604-WB*
 5/32" MAT'L

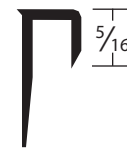

A-604-3*
 3/16" MAT'L

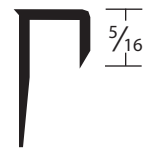

A-604-4*
 1/4" MAT'L

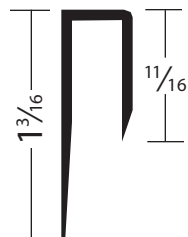

ACI-15
 FOR 5/16" MAT'L

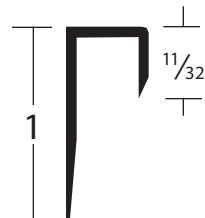

ACI-21
 FOR 5/16" MAT'L

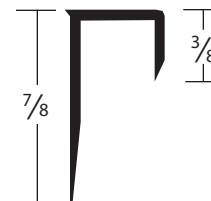

A604-6*
 3/8" MAT'L

* Non-Stock Specials. Available on Minimum Order Only.
 See Sections Listed Above with the Minimum Amount Required



WALLBOARD & TRIM MOULDINGS

	<i>ITEM#</i>	<i>Description</i>	<i>Finish</i>	<i>LGTH</i>	<i>PCK</i>	<i>WT</i>
<p>DIE 2334*</p>	410800	1/16" Cap TM80 (A604-L)	MFA	12'	40	24
<p>DIE 0204*</p>	410805	1/16" Flat Back TM81	MFA	12'	40	26
<p>DIE 4533*</p>	410820	1/16" Deep Slot Cap TM84	MFA	12'	40	26
<p>DIE 0214*</p>	410810	3/32" Wide Face TM82	MFA	12'	40	28
<p>DIE 2314*</p>	410815	3/32" Cap TM83	MFA	12'	40	26
<p>DIE 7441*</p>	409130	Punched and Slotted 3/32" Coving Cap CM901 (A-604-H)	MFA	8'	60	30



WALLBOARD & TRIM MOULDINGS

ITEM# Description Finish LGTH PCK WT

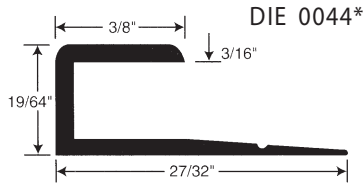

410720 3/16" Cap TM72 BA 8' 80 28

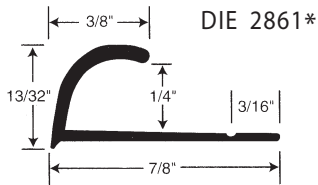

404049 1/4" Coving Cap CM400 HMF 12' 40 44
 404050 1/4" Coving Cap CM400 HB 12' 40 44

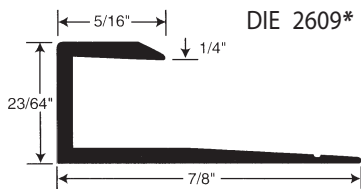

404101 1/4" Coving Cap CM401 (A-604-4) BA 12' 40 40

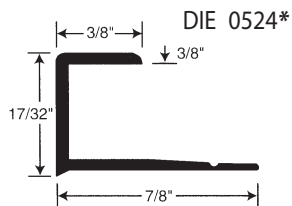

334190 3/8" Cap (A-604-6) BA 12' 12 18

* Non-Stock Specials. Available on Minimum Order Only.
 See Sections Listed Above with the Minimum Amount Required



WALLBOARD & TRIM MOULDINGS

	ITEM#	Description	Finish	LGTH	PCK	WT
<p>DIE 0326*</p>	410520	13/16" Offset Drill TM52	BA	12'	40	37
<p>DIE 0106*</p>	410585	3/32" Cove TM85	BA	12'	40	41
<p>DIE 0126*</p>	410900	1/16" Cove TM90	BA	12'	40	44
<p>DIE 0265*</p>	410905	1/16" Cove TM91	BA	12'	40	30
	410906	1/16" Cove TM91	BB	12'	40	30
<hr/>						
<p>DIE 0426*</p>	410910	1/16" Cove TM92	BA	12'	40	24
	410911	1/16" Cove TM92	BB	12'	40	24
<hr/>						
<p>DIE 5755*</p>	410935	1/16" Cove TM98	BA	12'	40	35

* Non-Stock Specials. Available on Minimum Order Only.

See Sections Listed Above with the Minimum Amount Required



WALLBOARD & TRIM MOULDINGS

ITEM# Description Finish LGTH PCK WT

DIE 0021*

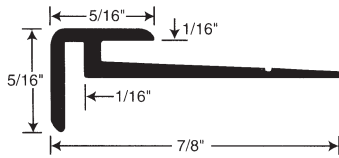

410915 3/64" Outside TM93 BA 12' 40 41



WALLBOARD & TRIM MOULDINGS

ITEM# Description Finish LGTH PCK WT

DIE 5044*

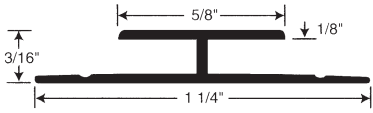

442057 3/32" Division WB110 EA 8' 50 44

DIE 0023*

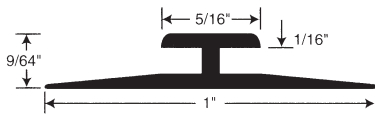

410920 .050 Division TM94 BA 12' 40 36

DIE 2413*

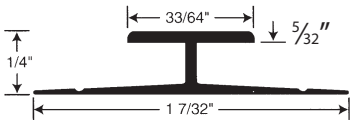

442050 1/8" Division WB103 BA 8' 100 88

DIE 2611*

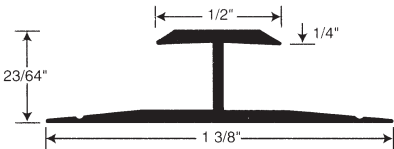

443010 1/4" Division WB303 BA 8' 100 85

* Non-Stock Specials. Available on Minimum Order Only.

See Sections Listed Above with the Minimum Amount Required



MARINE METALS & FACINGS

	DIE	ITEM#	Description	Finish	LGTH	PCK	WT
	1880*	360390	Gutter 1 Countersunk for #6 fasteners on 6" centers	BDMAC	12'	12	32
<hr/>							
	1010*	360116	Oval 3/4" x 3/16" (A-195) Countersunk for #6" fasteners on 6" centers	BMAC	12'	12	20
<hr/>							
	1666*	360250	Oval 1" x 3/16" (A-197) Countersunk for #6 fasteners on 6" centers	BMAC	12'	12	23
<hr/>							
	0508*	410210	Plain facing 3/4" TM21 (A-275) Countersunk for #4 oval head	BA	12'	40	35
<hr/>							
	0538*	410230	Plain facing 7/8" TM23 (A-36) Countersunk for #4 oval head	BA	12'	40	40
<hr/>							
	0558*	410250	Plain facing 1 1/16" TM25 (A-24) Countersunk for #4 oval head	BA	12'	40	47

* Non-Stock Specials. Available on Minimum Order Only.
See Sections Listed Above with the Minimum Amount Required



MARINE METALS & FACINGS

	DIE 0598*	ITEM#	Description	Finish	LGTH	PCK	WT
		410240	Plain facing 1 1/4" TM24 (A-276) Countersunk for #4 oval head	BA	12'	40	59
<hr/>							
	DIE 0578*						
		410195	Plain facing 1/2" TM19 (A-272) Countersunk for #4 oval head	BA	12'	40	27
<hr/>							
	DIE 0938*						
		360860	Plain facing 7/8" Countersunk for #6 fasteners on 6" centers	BMAC	12'	12	18
<hr/>							
	DIE 0937*						
		360515	Plain facing Countersunk for #6 fasteners on 6" centers	BMAC	12'	12	11
<hr/>							
	DIE 0838*						
		410310	Insert facing 7/8" TM31 Countersunk for #4 Flat head	BA	12'	40	39

*** Non-Stock Specials. Available on Minimum Order Only.**

See Sections Listed Above with the Minimum Amount Required



MARINE METALS & FACINGS

	DIE 0395*	ITEM#	Description	Finish	LGTH	PCK	WT
		333690	1" Tee	BA	12'	12	20

	DIE 0365*	ITEM#	Description	Finish	LGTH	PCK	WT
		333600	3/4" Tee	BA	12'	12	16

STAIR NOSINGS EXTRUDED ALUMINUM - APPLIED AFTER DESIGN

Stocked in 12' Lengths

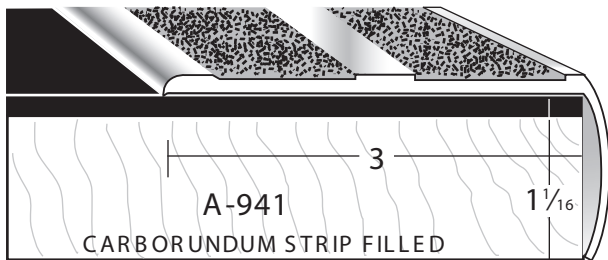

Stocked in 12' EA

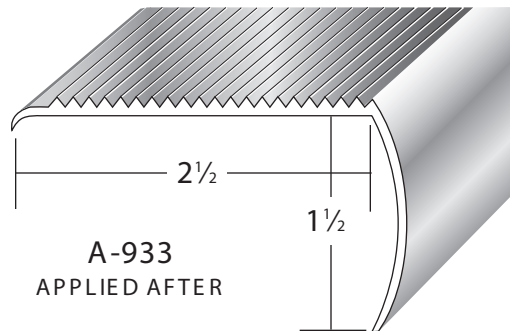

* Non-Stock Specials. Available on Minimum Order Only.
See Sections Listed Above with the Minimum Amount Required



MIRROR & GLASS MOULDINGS

"J" MOULDINGS

ALUMINUM – ANODIZED FINISH

STOCKED IN BRITE & GOLD

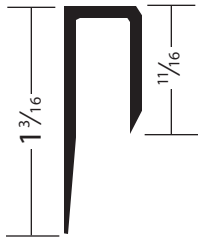

ACI-15
5/16" OPENING
Stocked in Brite,
Brushed Nickel, Matte
Black, Polished Black,
BREA & Oil Rub Bronze

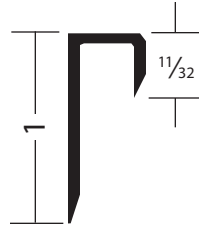

ACI-21
5/16" OPENING
Stocked in Brite,
Brushed Nickel, BREA,
Polished Black & Oil
Rub Bronze

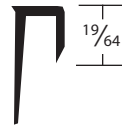

A-604-WB*
5/32" OPENING
Stocked Silver

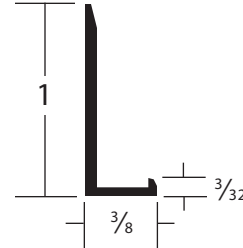

ACI 51
LITTLE LIP
Stocked in Brite

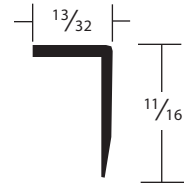

ACI 30
END CAP
Stocked in Brite

Actual Sizes

ALL "J" TRIMS STOCKED 12 FT. AND SUPPLIED WITH PUNCHED AND SLOTTED BACK FLANGES

ALUMINUM – POLISHED & ANODIZED FINISH



L BAR
ACI-26
Size 1" x 5/16"
Punched & slotted
back flange
Stocked in Brite

ALUMINUM

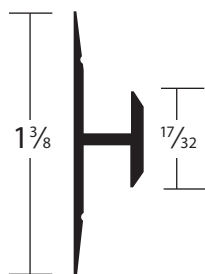

DIVIDER
1021-4*
1/4" OPENING
Available Brite,



CLOSURE STRIP
ACI-29
Stocked in Brite
and Brushed Nickel

* Non-Stock Specials. Available on Minimum Order Only.
See Sections Listed Above with the Minimum Amount Required



ALUMINUM TRACK ASSEMBLY FOR SLIDING GLASS DOORS



VINYL GUIDE
VG-3

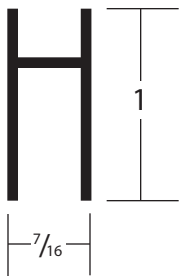

SHOE
ACI-32

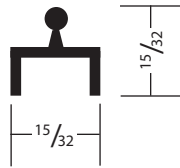

SINGLE TRACK
ACI-38

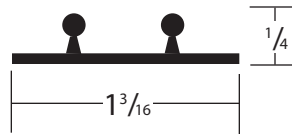

DOUBLE TRACK
ACI-34

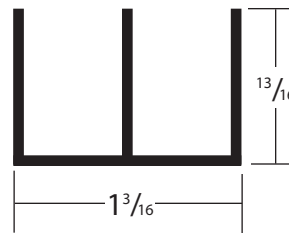

DOUBLE CHANNEL
ACI-37

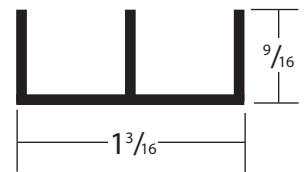

TOP CHANNEL
ACI-33

PART NO.	DESCRIPTION
2351	SLIDING GLASS LOCK CHROME PLATED, RACHET TYPE

Andscot

Fast Grab Mirror Mastic

**Instantly Grabs Mirrors While Adhesive Cures
Bonds To All Types of Mirrors
Strong Permanent Bond Which Remains Flexible**

- Does Not Sag, Will Not Shrink
- Solvent Free Formulation, Easy & Safe to Use
- Easy To Dispense, Remains Consistent, Low Odor
- Can Be Compressed To 1/32" Or Build Out To 2"

MEETS AND EXCEEDS

- Conforms to OTC Rule for Adhesive
- Conforms to California Proposition 65
- Meets USDA Requirements For Non-Food Contact
- Meets Requirements of CARB & SCAQMD



10 fl. oz. Cartridge

New Fast Grab Mirror Mastic:
This is a technologically advanced, environmentally safe adhesive for installing all types of mirrors. Hybrid/Urethane formulation provides installers with a solvent free adhesive, that's fast grabbing, easy to use and provides a strong permanently flexible bond.

PROVEN BEST! GUNTHER MIRROR MASTICS

ULTRA A/BOND™



Two time tested superior bonding mirror mastics designed for durable, quality installations.

- Ultra/Bond gives the ultimate in convenient drying and strength. It can be gunned from cartridges at a wide variety of temperatures, cutting waste while saving time. A unique formulation gives ultimate bonding while remaining flexible for structural and temperature changes over the life of the installation.



PROVEN BEST! GUNTHER MIRROR & MORE CLEANER™

A Superior Glass and Mirror All-purpose Cleaner



TESTED AND APPROVED FOR MIRRORS.

A superior mirror and glass all-purpose cleaner. Discover the wonders of this ammonia and vinegar free cleaner. Dissolves dirt, grease and most deposits. Leaves no film and cleans streak-free. Cleans glass, porcelain, tile, chrome, stainless steel, marble and appliances sparkling clean. You'll find it very useful for most cleaning jobs.

UNIQUE 5-GALLON BAG-IN-A-BOX DISPOSABLE CONTAINER.

Economical bulk container. Stackable, convenient to ship, takes less storage space than other containers and is easy to handle.



GLASS OR ACRYLIC MIRROR PLATES

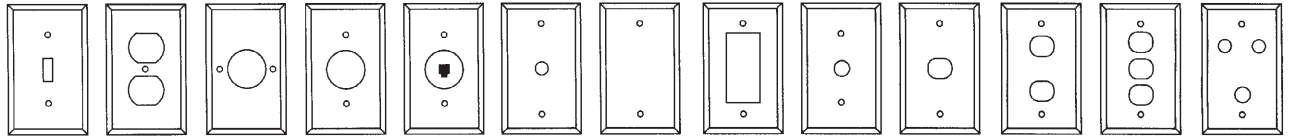

A-1 Single TOGGLE
B-5 Single DUPLEX
D-8 Single PHONE (1-3/8" Hole)
D-9 Single PHONE (1-3/8" Hole)
MT-1 Modular PHONE With Wiring
D-10 Single T.V. (3/8" Hole) PHONE (5/8" Hole)
D-11 Single BLANK
102 Single DECORA
104 Single DIMMER
106 Single 1 HOLE DESPARD
107 Single 2 HOLE DESPARD
108 Single 3 HOLE DESPARD
109 Single ALARM (3/8" hole)

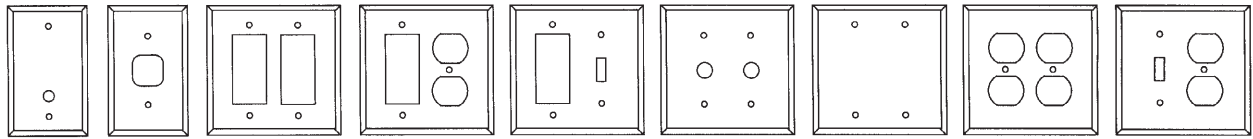

111 Single T.V.OFFSET (3/8") Hole
112 Single PHONE (Square)
202 Double DECORA
205 DECORA DUPLEX
206 DECORA TOGGLE
207 DOUBLE DIMMER
208 DOUBLE BLANK
B-6 DOUBLE DUPLEX
C-7 SWITCH DUPLEX

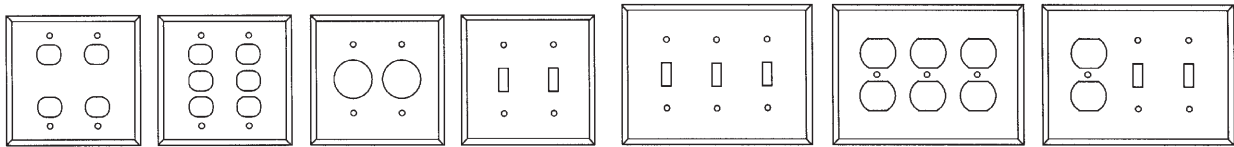

209 4 HOLE DESPARD
210 6 HOLE DESPARD
211 DOUBLE PHONE (1-3/8" Hole)
A-2 DOUBLE TOGGLE
A-3
B-3
C-8

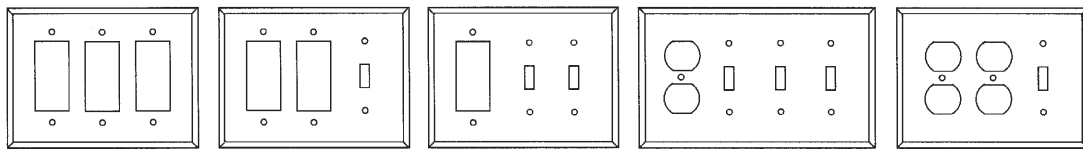

302 **305** **306** **C-9** **C-10**

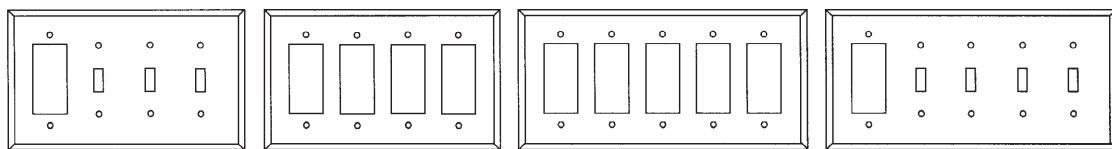

406 **402** **502** **506**

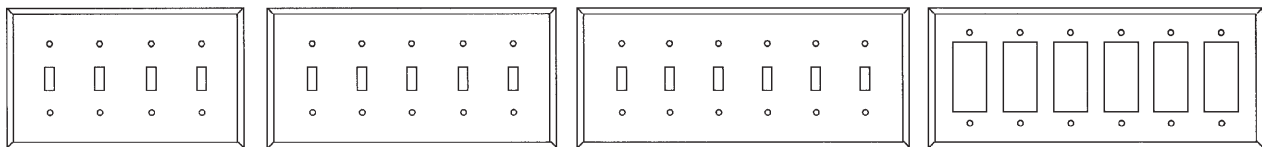

A-4 **A-5** **A-6** **602**

SUPER SIZE PLATES ARE AVAILABLE IN 1/8" CLEAR OR BRONZE WITH NO GASKET OR 1/4" CLEAR OR BRONZE WITH GASKET - IN SINGLE, DOUBLE, TRIPLE, 4-GANG, 5-GANG AND 6-GANG.

*** Non-Stock Specials. Available on Minimum Order Only.
 See Sections Listed Above with the Minimum Amount Required**



ANDSCOT QUALITY FOAM MOUNTING TAPES FOR USE WITH ALL MIRROR PRODUCTS

- As a shim the tape keeps butted mirror edges on the same plane for straight reflection lines.
- Tape can be folded easily to create needed thickness.
- Firmly secures mirror to painted or unpainted metal bifold doors.
- Mounts beveled mirror overlays onto mirrored wall.
- A must when attaching aluminum extrusions to glass for shower doors.
- Acts as a gasket between glass to glass portions of glass furniture.
- Tape will not be affected by mastic used bond mirror to wall.

Our foam tape has been tested by mirror manufacturers and is chemically compatible with all coatings including UV cured and lead-free mirror paint backings. It will not corrode the mirror backing or cause ghosting.

Provides production flexibility

- Tape can be applied to either surface first.
- Safe - Our cured, pressure sensitive adhesive is safe for workers to handle and is environmentally sound.
- The paper liner is biodegradable.
- Consistent performance is engineered into all our tapes - Adhesive mass is the same every time.

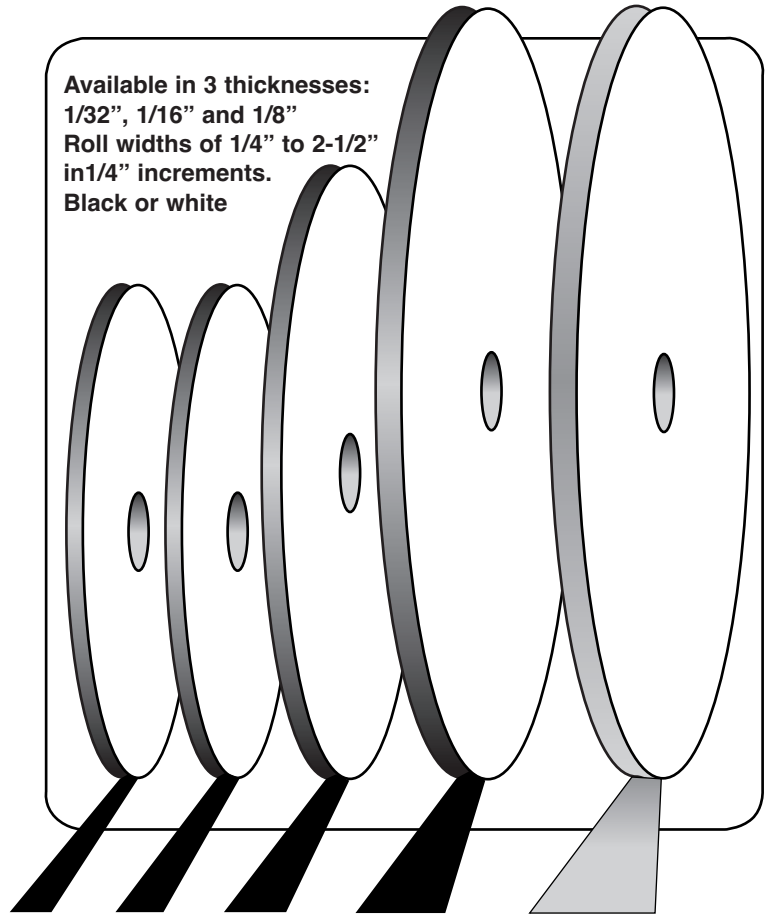

WHEN TO USE...	RUBBER	OR	ACRYLIC
Bifold Doors	X		
Shower Enclosures	X		
Beveled Overlays	X		X Acrylic allows for repositioning
Shims For Seam Reflection Lines	X		
High Temperature (Environment over 100°F. continuous)			X



INDUSTRIAL METALS

	ITEM#	Description	Finish	LGTH	PCK	WT
<p>DIE 0439*</p>	306321	Flatbar 1" x 1/16"	EA	12'	6	8
<p>DIE 1005</p>	300030	Flatbar 1/2" x 1/8" (A-811)	EA	12'	6	8
<p>DIE 1048</p>	300220	Flatbar 3/4" x 1/8" (A-812)	EA	12'	6	9
<p>DIE 1004</p>	300020	Flatbar 1" x 1/8" (A-808)	EA	12'	6	14
<p>DIE 1068*</p>	300306	Flatbar 1 1/4" x 1/8"	EA	12'	6	15
<p>DIE 1049</p>	300228	Flatbar 1 1/2" x 1/8" (A-796)	EA	12'	6	18

* Non-Stock Specials. Available on Minimum Order Only.

See Sections Listed Above with the Minimum Amount Required



INDUSTRIAL METALS

	ITEM#	Description	Finish	LGTH	PCK	WT
<p>DIE 1285</p>	300895	Channel 5/16" x 3/8" (A-236)	EA	12'	6	6
<p>DIE 1362*</p>	301201	Channel 5/16" x 1/2"	EA	12'	6	11
<p>DIE 2161</p>	303751	Channel 5/16" x 3/4" (A-734)	EA	12'	6	12
<p>DIE 1347</p>	301151	Channel 7/16" x 1/4" (A-235)	EA	12'	6	10
<p>DIE 1346</p>	301143	Channel 9/16" x 1/2" (A-244)	EA	12'	6	10
<p>DIE 2223*</p>	304001	Channel 13/16" x 1/4"	EA	12'	6	10
<p>DIE 1038*</p>	300178	Channel 1/2" x 5/16"	EA	12'	6	12

*** Non-Stock Specials. Available on Minimum Order Only.
See Sections Listed Above with the Minimum Amount Required**



INDUSTRIAL METALS

ITEM# Description Finish LGTH PCK WT

DIE 1040*

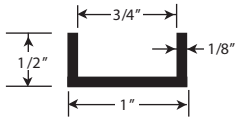

300187 Channel 1/2" x 3/4" EA 12' 6 20

DIE 1538*

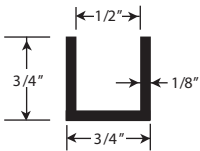

301901 Channel 3/4" x 1/2" EA 12' 6 22

DIE 1710*

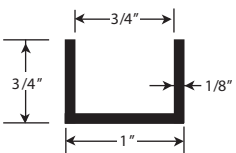

302501 Channel 3/4" x 3/4" EA 12' 6 26

DIE 1041*

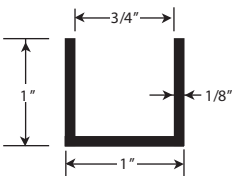

300191 Channel 1" x 3/4" EA 12' 6 32

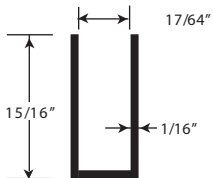

A-237* Channel 7/8" x 17/64" EA 12' 6

* Non-Stock Specials. Available on Minimum Order Only.

See Sections Listed Above with the Minimum Amount Required



INDUSTRIAL METALS

	<i>ITEM#</i>	<i>Description</i>	<i>Finish</i>	<i>LGTH</i>	<i>PCK</i>	<i>WT</i>
<p>DIE 1225*</p>	300651	Angle 3/4" x 1/2"	EA	12'	6	6
<p>DIE 1750*</p>	302651	Angle 3/4" x 3/8"	EA	12'	6	10
<p>DIE 1033*</p>	300158	Angle 1" x 1/2"	EA	12'	6	12
<p>DIE 1249*</p>	300751	Angle 2 1/8" x 1"	EA	12'	6	34
<p>DIE 0141</p>	306001	Equal Angle 1/2" x 1/2" (A-103)	EA	12'	6	6

*** Non-Stock Specials. Available on Minimum Order Only.
See Sections Listed Above with the Minimum Amount Required**



INDUSTRIAL METALS

	DIE 0151	ITEM#	Description	Finish	LGTH	PCK	WT
		306051	Equal Angle 3/4" x 3/4" (A-803)	EA	12'	6	8
		306101	Equal Angle 1" x 1" (A-903)	EA	12'	6	12
		300083	Equal Angle 3/4" x 3/4" (A-1185)	EA	12'	6	16
		300091	Equal Angle 1" x 1" (A-1187)	EA	12'	6	22
		300110	Equal Angle 1 1/2" x 1 1/2" (A-1163)	EA	12'	6	32
		300450	Equal Angle 2" x 2" (A-1202)	EA	12'	6	44

*** Non-Stock Specials. Available on Minimum Order Only.
See Sections Listed Above with the Minimum Amount Required**



INDUSTRIAL METALS

ITEM#	Description	Finish	LGTH	PCK	WT
-------	-------------	--------	------	-----	----

DIE 1447*

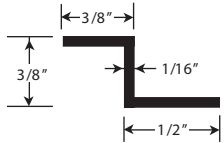

331350	Z Bar 3/8" x 1/2" x 3/8"	MF	12'	12	18
--------	--------------------------	----	-----	----	----

DIE 0569*

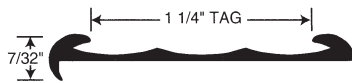

331940	Conventional Molding 1 1/4" tag	BA	12'	12	20
--------	---------------------------------	----	-----	----	----

DIE 1356*

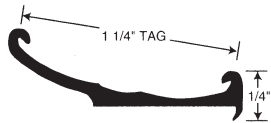

331260	Standard Concave Molding 1 1/4" tag x 1/4"	BA	12'	12	23
--------	---	----	-----	----	----