

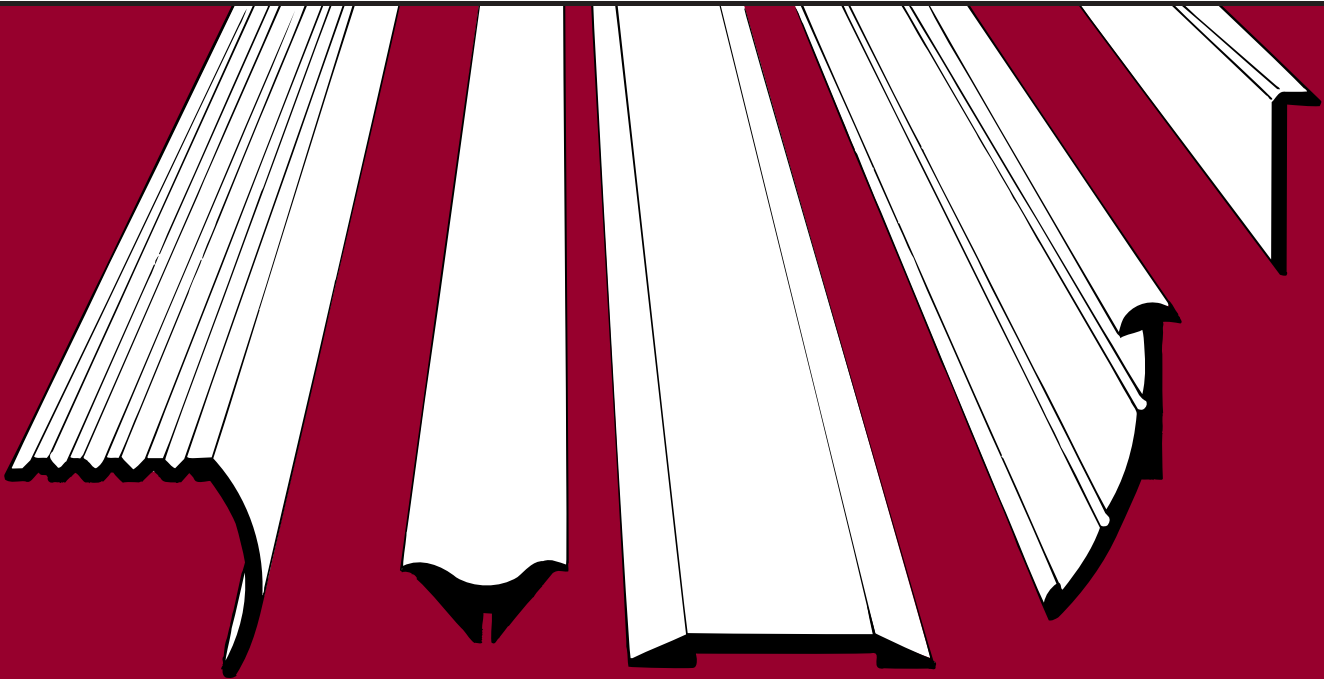

*Andscot Company, Inc.*

9117 MEDILL AVENUE, FRANKLIN PARK, ILLINOIS 60131

Chicago Phone: 773/625-1240 • Suburban Phone: 847/455-5800 • FAX: 773/625-1242



*Aluminum and Stainless Steel*

**MOULDINGS**

# General Information

The items ILLUSTRATED in this catalog are stock and available for shipment from ANDSCOT warehouse.

Unless otherwise noted, all ALUMINUM TRIMS are stocked with an Etched & Anodized Finish with STAINLESS STEEL TRIMS, a Brite Finish.

Material may not be returned for credit without prior written authorization from Andscot. Where returns are authorized and Andscot is not at fault, the credit allowed will be subject to a 15% re-stocking charge.

MINIMUM ORDER: Minimum order on a charge is \$20.00.

CUTTING TO LENGTH: Minimum cutting charge of \$15.00 with apply to all cut orders.

FREIGHT: All sales are F.O.B. Our Warehouse, unless otherwise quoted.

CLAIMS: Any shipment damaged or lost in transit is the responsibility of the carrier.

We are not responsible for damage, loss or delay after goods are picked up by the carrier. When there is a LOSS OR APPARENT VISIBLE DAMAGE to a shipment revealed, DO NOT give the carrier a clear receipt.

Note such damage on the carrier's delivery receipt and HAVE THE DRIVER SIGN THE RECEIPT.

CONCEALED DAMAGE OR LOSS: Please follow these instructions in the event of CONCEALED DAMAGE OR LOSS.

1. Advise the delivering carrier in writing no more than 15 days after the delivery, and request the carrier to make an inspection.
2. RETAIN THE CONTAINER and ALL PACKING MATERIAL of the damaged or lost material that was shipped in for the carrier's inspection.
3. SHORTAGES must be reported to us within 15 days after receipt of goods.

## INDEX TO CONTENTS

TYPE OF TRIM	PAGE	TYPE OF TRIM	PAGE
Nosings and Caps	1	Mirror Edge Sealer, Clips & Mirror Mastic	12
Wallboard & Trim Mouldings	2-6	Mirror Plates	13
Marine Metals & Facings	7-9	Foam Mounting Tapes	14
Stairnosings, Binders & Door Track	9	Glass Cleaner, Stainless Angles & Channels	15
Mirror and Glass Trims	10	Industrial Metals	16
Aluminum Track Assembly & Pulls	11		



**NOSINGS APPLIED-AFTER**  
**EXTRUDED ALUMINUM MOULDINGS - BUFFED AND CLEAR FINISH**

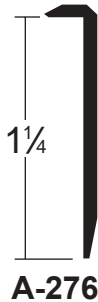
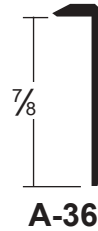
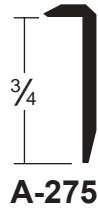
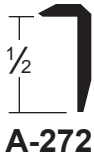

**CAP MOULDINGS**

**EXTRUDED ALUMINUM MOULDINGS - BUFFED AND CLEAR FINISH**

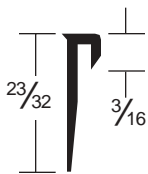

**A-604L**  
 1/16" MAT'L  
 MFA



**A-604S**  
 3/32" MAT'L  
 MFA

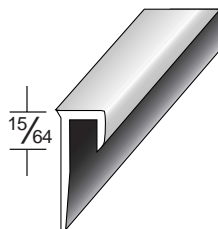

**A-604H**  
 1/8" MAT'L  
 MFA

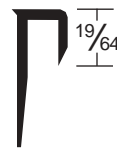

**A-604-WB**  
 5/32" MAT'L

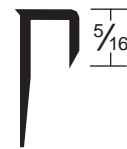

**A-604-3**  
 3/16" MAT'L

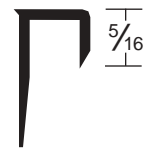

**A-604-4**  
 1/4" MAT'L

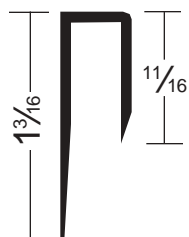

**ACI-15**  
 FOR 5/16" MAT'L

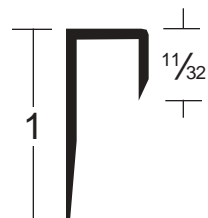

**ACI-21**  
 FOR 5/16" MAT'L

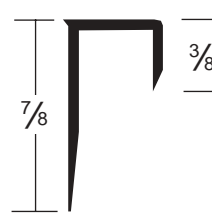

**A604-6**  
 3/8" MAT'L

**\* Non-Stock Specials. Available on Minimum Order Only.**  
**See Sections Listed Above with the Minimum Amount Required**



## WALLBOARD & TRIM MOULDINGS

	ITEM#	Description	Finish	LGTH	PCK	WT
<p><b>DIE 2334</b></p>	410800	1/16" Cap TM80 (A604-L)	MFA	12'	40	24
<p><b>DIE 0204*</b></p>	410805	1/16" Flat Back TM81	MFA	12'	40	26
<p><b>DIE 4533*</b></p>	410820	1/16" Deep Slot Cap TM84	MFA	12'	40	26
<p><b>DIE 0214*</b></p>	410810	3/32" Wide Face TM82	MFA	12'	40	28
<p><b>DIE 2314*</b></p>	410815	3/32" Cap TM83	MFA	12'	40	26
<p><b>DIE 7441</b></p>	409130	<b>Punched and Slotted</b> 3/32" Coving Cap CM901 (A-604-H)	MFA	8'	60	30

**\* Non-Stock Specials. Available on Minimum Order Only.  
See Sections Listed Above with the Minimum Amount Required**



## WALLBOARD & TRIM MOULDINGS

	ITEM#	Description	Finish	LGTH	PCK	WT
<p><b>DIE 0044*</b></p>	410720	3/16" Cap TM72	BA	8'	80	28
<p><b>DIE 2861*</b></p>	404049	1/4" Coving Cap CM400	HMF	12'	40	44
	404050	1/4" Coving Cap CM400	HB	12'	40	44
<p><b>DIE 2609</b></p>	404101	1/4" Coving Cap CM401 (A-604-4)	BA	12'	40	40
<p><b>DIE 0514*</b></p>	404110	5/16" Cap CM402	BA	12'	40	47
<p><b>DIE 0524</b></p>	334190	3/8" Cap (A-604-6)	BA	12'	12	18

\* Non-Stock Specials. Available on Minimum Order Only.  
See Sections Listed Above with the Minimum Amount Required



## WALLBOARD & TRIM MOULDINGS

	ITEM#	Description	Finish	LGTH	PCK	WT
<p><b>DIE 0326*</b></p>	410520	13/16" Offset Drill TM52	BA	12'	40	37
<p><b>DIE 0106*</b></p>	410585	3/32" Cove TM85	BA	12'	40	41
<p><b>DIE 0126*</b></p>	410900	1/16" Cove TM90	BA	12'	40	44
<p><b>DIE 0265*</b></p>	410905	1/16" Cove TM91	BA	12'	40	30
	410906	1/16" Cove TM91	BB	12'	40	30
<p><b>DIE 0426*</b></p>	410910	1/16" Cove TM92	BA	12'	40	24
	410911	1/16" Cove TM92	BB	12'	40	24
<p><b>DIE 5755*</b></p>	410935	1/16" Cove TM98	BA	12'	40	35
	410936	1/16" Cove TM98	BB	12'	40	35

\* Non-Stock Specials. Available on Minimum Order Only.

See Sections Listed Above with the Minimum Amount Required



**WALLBOARD & TRIM MOULDINGS**

ITEM#	Description	Finish	LGTH	PCK	WT
-------	-------------	--------	------	-----	----

**DIE 2416\***

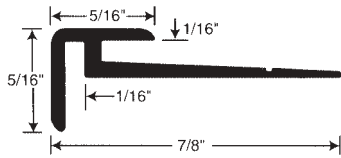

410915	3/64" Outside TM93	BA	12'	40	4
--------	--------------------	----	-----	----	---



## WALLBOARD & TRIM MOULDINGS

ITEM#	Description	Finish	LGTH	PCK	WT
-------	-------------	--------	------	-----	----

**DIE 0023\***

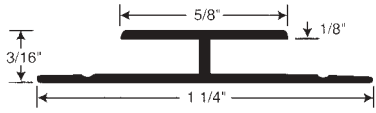

442057	3/32" Division WB110	EA	8'	50	44
--------	----------------------	----	----	----	----

**DIE 2413\***

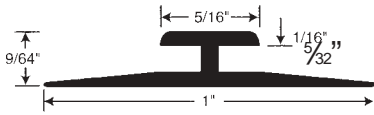

410920	.050 Division TM94	BA	12'	40	36
--------	--------------------	----	-----	----	----

**DIE 2611\***

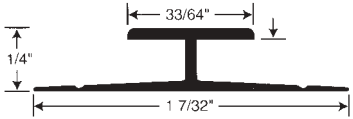

442050	1/8" Division WB103	BA	8'	100	88
--------	---------------------	----	----	-----	----

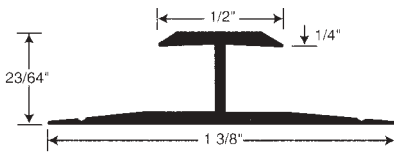

443010	1/4" Division WB303	BA	8'	100	85
--------	---------------------	----	----	-----	----

**\* Non-Stock Specials. Available on Minimum Order Only.**

**See Sections Listed Above with the Minimum Amount Required**



**MARINE METALS & FACINGS**

	<b>DIE 1880*</b>	<b>ITEM#</b>	<b>Description</b>	<b>Finish</b>	<b>LGTH</b>	<b>PCK</b>	<b>WT</b>
		360390	Gutter 1 Countersunk for #6 fasteners on 6" centers	BDMAC	12'	12	32
<hr/>							
	<b>DIE 1010†</b>						
		360116	Oval 3/4" x 3/16" (A-195) Countersunk for #6" fasteners on 6" centers	BMAC	12'	12	20
<hr/>							
	<b>DIE 1666†</b>						
		360250	Oval 1" x 3/16" (A-197) Countersunk for #6 fasteners on 6" centers	BMAC	12'	12	23
<hr/>							
	<b>DIE 0508</b>						
		410210	Plain facing 3/4" TM21 (A-275) Countersunk for #4 oval head	BA	12'	40	35
<hr/>							
	<b>DIE 0538</b>						
		410230	Plain facing 7/8" TM23 (A-36) Countersunk for #4 oval head	BA	12'	40	40
<hr/>							
	<b>DIE 0558</b>						
		410250	Plain facing 1 1/16" TM25 (A-24) Countersunk for #4 oval head	BA	12'	40	47

**\* Non-Stock Specials. Available on Minimum Order Only.  
See Sections Listed Above with the Minimum Amount Required**



## MARINE METALS & FACINGS

	<b>DIE 0598</b>	<b>ITEM#</b>	<b>Description</b>	<b>Finish</b>	<b>LGTH</b>	<b>PCK</b>	<b>WT</b>
	410240	Plain facing 1 1/4" TM24 (A-276) Countersunk for #4 oval head	BA	12'	40	59	
<hr/>							
	<b>DIE 0578</b>						
	410195	Plain facing 1/2" TM19 (A-272) Countersunk for #4 oval head	BA	12'	40	27	
<hr/>							
	<b>DIE 0938*</b>						
	1360860	Plain facing 7/8" Countersunk for #6 fasteners on 6" centers	BMAC	12'	12	18	
<hr/>							
	<b>DIE 0937*</b>						
	360515	Plain facing Countersunk for #6 fasteners on 6" centers	BMAC	12'	12	11	
<hr/>							
	<b>DIE 0838*</b>						
	410310	Insert facing 7/8" TM31 Countersunk for #4 Flat head	BA	12'	40	39	

**\* Non-Stock Specials. Available on Minimum Order Only.**

**See Sections Listed Above with the Minimum Amount Required**



**MARINE METALS & FACINGS**

	<b>DIE 0395*</b>	<b>ITEM#</b>	<b>Description</b>	<b>Finish</b>	<b>LGTH</b>	<b>PCK</b>	<b>WT</b>
		333690	1" Tee	BA	12'	12	20

	<b>DIE 0365*</b>	<b>ITEM#</b>	<b>Description</b>	<b>Finish</b>	<b>LGTH</b>	<b>PCK</b>	<b>WT</b>
		333600	3/4" Tee	BA	12'	12	16

**STAIR NOSINGS** EXTRUDED ALUMINUM - APPLIED AFTER DESIGN

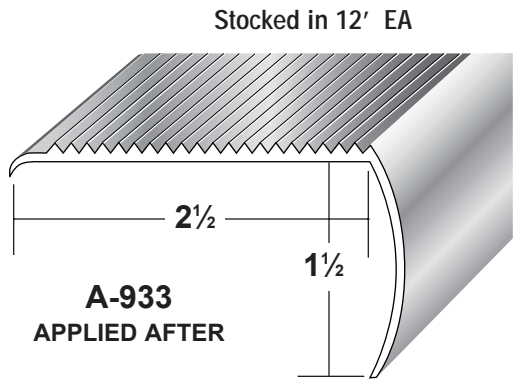
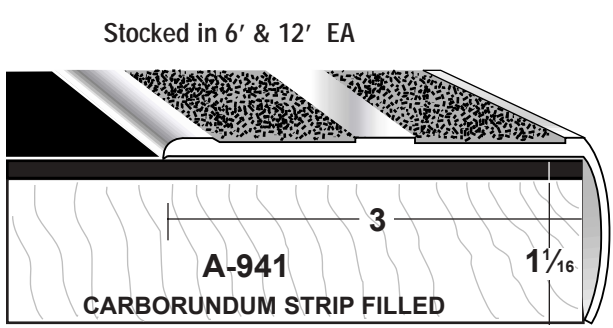

**EDGINGS • BINDINGS**

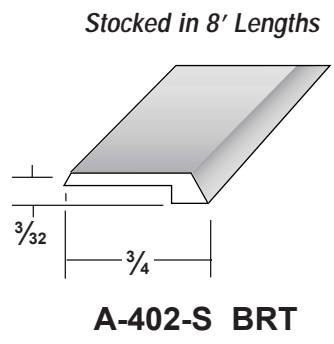

**SLIDING DOOR TRACK UPPER AND LOWER**

Stocked in 4 ft. and 6 ft. sets



**AP-470-4** 1/4" panels



**AP-472-4**

\* Non-Stock Specials. Available on Minimum Order Only.  
See Sections Listed Above with the Minimum Amount Required



## MIRROR & GLASS MOULDINGS

### "J" MOULDINGS

ALUMINUM – ANODIZED FINISH

STOCKED IN BRITE & GOLD

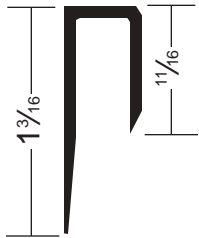

**ACI-15**  
5/16" OPENING

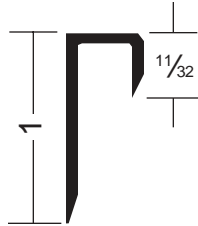

**ACI-21**  
5/16" OPENING

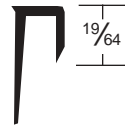

**A-604-WB**  
5/32" OPENING

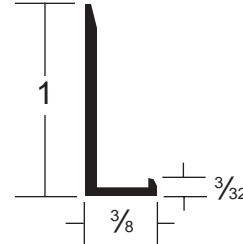

**ACI 51**  
LITTLE LIP

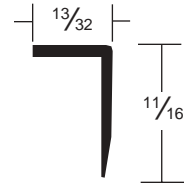

**ACI 30**  
END CAP

ACI-15, ACI-21 stocked in Brite, Brushed Nickel, Brushed Satin, & Oil Rubbed Bronze. 12' lengths punched and slotted back flanges.

ACI-51 and ACI-30 Stocked in Brite

A-604-WB stocked in Silver

ALUMINUM – POLISHED & ANODIZED FINISH



ACI-26 "L" BAR  
Size 1" X 5/16"  
Punched & Slotted  
back flange.  
Stocked in Brite

ALUMINUM

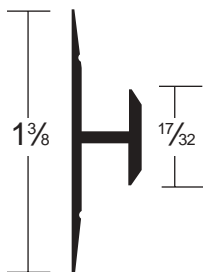

DIVIDER  
1021-4\*  
1/4" OPENING  
CALL FOR  
FINISHES

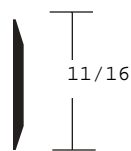

ACI-29 CLOSURE STRIP  
STOCKED BRITE



## ALUMINUM TRACK ASSEMBLY FOR SLIDING GLASS DOORS

Your choice of ball-bearing or steel wheels



**VINYL GUIDE**  
VG-3



**STEEL WHEEL**  
SW-1

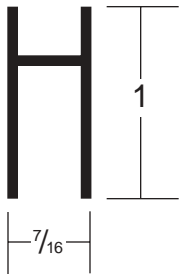

**SHOE**  
ACI-32

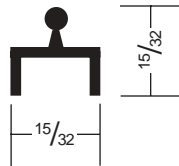

**SINGLE TRACK**  
ACI-38

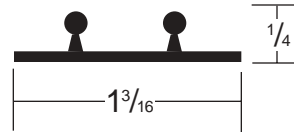

**DOUBLE TRACK**  
ACI-34

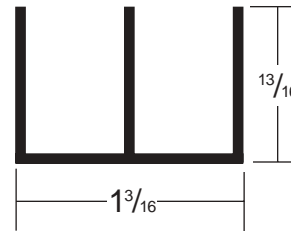

**DOUBLE CHANNEL**  
ACI-37

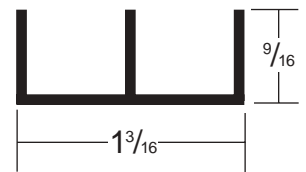

**TOP CHANNEL**  
ACI-33

## ANDSCOT PULLS - ACRYLIC MIRROR & PLASTIC

We have styles and sizes to cover most applications. If you do not see it call 1-800-832-5800

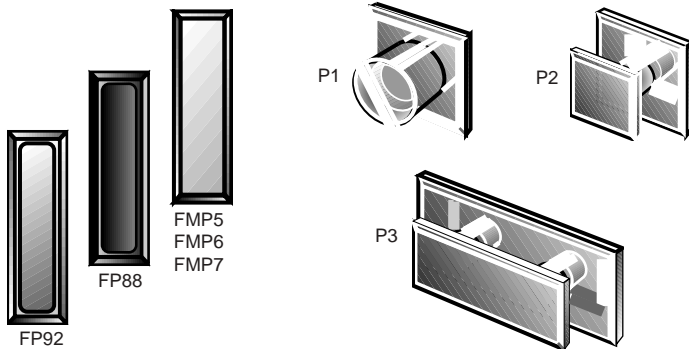

PART NO.	W x H x T	SPECIFY COLOR
<b>P1</b>	1" Sq. Knob Acrylic	Clear Mirror
<b>P2</b>	1-3/4" Sq. Pull Acrylic	Clear Mirror
<b>P3</b>	5" x 2" Pull Acrylic	Clear Mirror
<b>FP92</b>	(BRIGHT SHINY FINISH)	Gold Plated
<b>FP88</b>	3/4" x 2-3/4" x 1/8" (SATIN FINISH)	Aluminum Black, Clear Bronze, Gold
<i>Note: O.K. to mix FP88 colors in 20's, when you order in 100's.</i>		
<b>FMP5</b>	1" x 3" x 1/8"	Clear Acrylic Mirror
<b>FMP6</b>	3/4" x 2-3/4" x 1/8"	Clear Acrylic Mirror
<b>FMP7</b>	1" x 3" x 1/4" (PACKED IN 20'S)	Clear Acrylic Mirror

PART NO.	DESCRIPTION
<b>2351</b>	SLIDING GLASS LOCK <i>CHROME PLATED, RACHET TYPE</i>
<b>DGC-1</b>	DIAMOND GLASS CUTTER <i>OUTLASTS ALL WHEEL CUTTERS FOR SAME COST!</i>



EASY TO USE!  
**GUNTHER  
 SEAL-KWIK™  
 MIRROR  
 EDGE SEALER**

A safe, proven formula for protecting mirror edges against black edge and other contaminants



**LABOR SAVING!** All-in-one package with dauber top and screw off cap makes a fast, easy job of mirror edge sealing.  
**ECONOMICAL!** One 4 oz. bottle lasts and lasts. Covers 20,000 linear inches of mirror edge. No noxious odor.  
**FAST DRYING!** Dries clear, will not yellow or crack over time. Non-flammable.  
**QUALITY!** Careful quality control assures a consistent formula and proven compatible with mirror backing.



**GUNTHER  
 MIRROR  
 CLIPS**

Compare Gunther Mirror Clips with other clips and you'll see ours are made of top-quality materials.

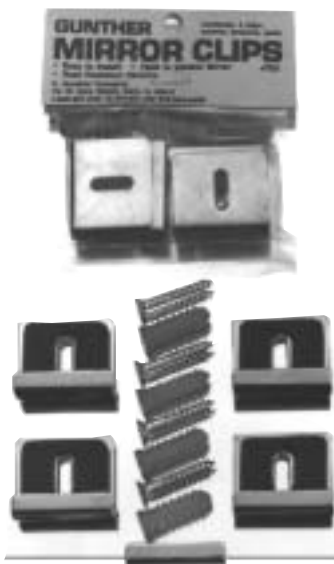

- Each package contains a set of four padded clips with screws and wall anchors.
- Easy to read instructions.
- Clips are Brite rust-resistant chrome finish.
- Each clip is padded on the back to protect the back of the mirror from being scratched by the screw heads. It also holds mirror into front of leg.
- Heavyweight clip provides excellent support for mirrors.
- Slotted screw holes allow for ease of installation.
- Packages are designed for easy display. Ask for #700 mirror clips.



PROVEN BEST!  
**GUNTHER  
 MIRROR  
 MASTICS**

**ULTRA/BOND™  
 AND  
 EXTRA/BUILD™**

The mastic of choice for the new MGM Grand and Treasure Island Resorts in Las Vegas.



Two time tested superior bonding mirror mastics designed for durable, quality installations.

- **Ultra/Bond** gives the ultimate in convenient drying and strength. It can be gunned from cartridges at a wide variety of temperatures, cutting waste while saving time. A unique formulation gives ultimate bonding while remaining flexible for structural and temperature changes over the life of the installation.
- **Extra/Build** is formulated for uneven or bowed walls, and can be gunned from cartridges at a wide variety of temperatures. Builds up to 2-1/2" without sag giving full adjustability. Has strong adhesion and will not become brittle over time.





## GLASS OR ACRYLIC MIRROR PLATES

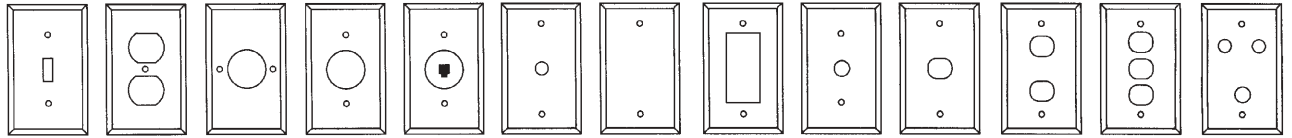

**A-1** Single TOGGLE  
**B-5** Single DUPLEX  
**D-8** Single PHONE (1-3/8" Hole)  
**D-9** Single PHONE (1-3/8" Hole)  
**MT-1** Modular PHONE With Wiring  
**D-10** Single T.V. (3/8" Hole) PHONE (5/8" Hole)  
**D-11** Single BLANK  
**102** Single DECORA  
**104** Single DIMMER  
**106** Single 1 HOLE DESPARD  
**107** Single 2 HOLE DESPARD  
**108** Single 3 HOLE DESPARD  
**109** Single ALARM (3/8" hole)

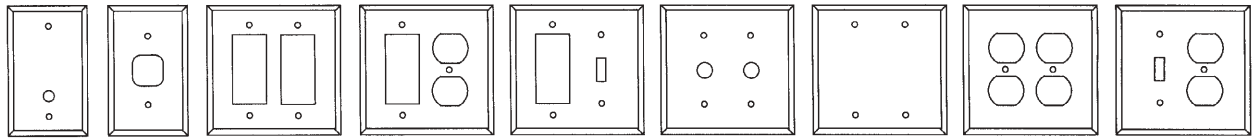

**111** Single T.V. OFFSET (3/8" Hole)  
**112** Single PHONE (Square)  
**202** Double DECORA  
**205** DECORA DUPLEX  
**206** DECORA TOGGLE  
**207** DOUBLE DIMMER  
**208** DOUBLE BLANK  
**B-6** DOUBLE DUPLEX  
**C-7** SWITCH DUPLEX

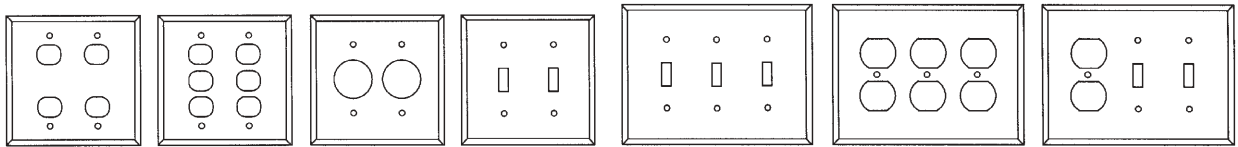

**209** 4 HOLE DESPARD  
**210** 6 HOLE DESPARD  
**211** DOUBLE PHONE (1-3/8" Hole)  
**A-2** DOUBLE TOGGLE  
**A-3**  
**B-3**  
**C-8**

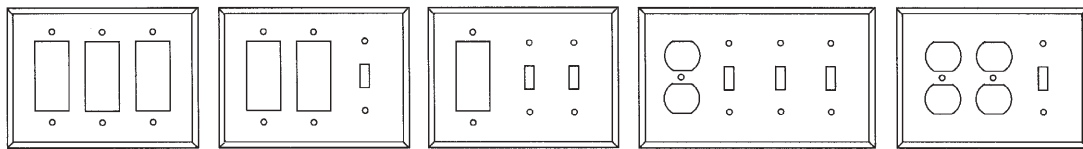

**302** **305** **306** **C-9** **C-10**

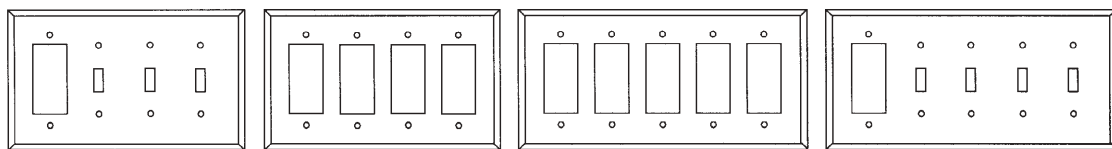

**406** **402** **502** **506**

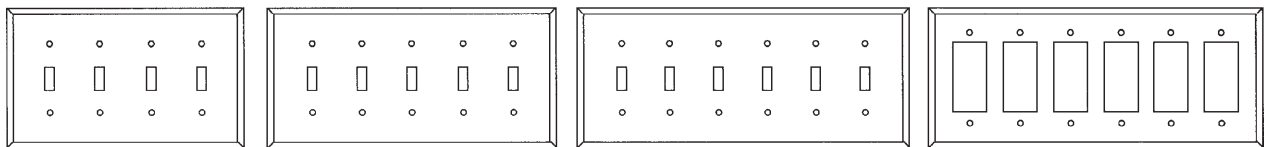

**A-4** **A-5** **A-6** **602**

**SUPER SIZE PLATES ARE AVAILABLE IN 1/8" CLEAR OR BRONZE WITH NO GASKET OR 1/4" CLEAR OR BRONZE WITH GASKET – IN SINGLE, DOUBLE, TRIPLE, 4-GANG, 5-GANG AND 6-GANG.**

**\* Non-Stock Specials. Available on Minimum Order Only.  
 See Sections Listed Above with the Minimum Amount Required**



## ANDSCOT QUALITY FOAM MOUNTING TAPES FOR USE WITH ALL MIRROR PRODUCTS

- As a shim the tape keeps butted mirror edges on the same plane for straight reflection lines.
- Tape can be folded easily to create needed thickness.
- Firmly secures mirror to painted or unpainted metal bifold doors.
- Mounts beveled mirror overlays onto mirrored wall.
- A must when attaching aluminum extrusions to glass for shower doors.
- Acts as a gasket between glass to glass portions of glass furniture.
- Tape will not be affected by mastic used bond mirror to wall.

Our foam tape has been tested by mirror manufacturers and is chemically compatible with all coatings including UV cured and lead-free mirror paint backings. It will not corrode the mirror backing or cause ghosting.

### Provides production flexibility

- Tape can be applied to either surface first.
- Safe - Our cured, pressure sensitive adhesive is safe for workers to handle and is environmentally sound.
- The paper liner is biodegradable.
- Consistent performance is engineered into all our tapes - Adhesive mass is the same every time.

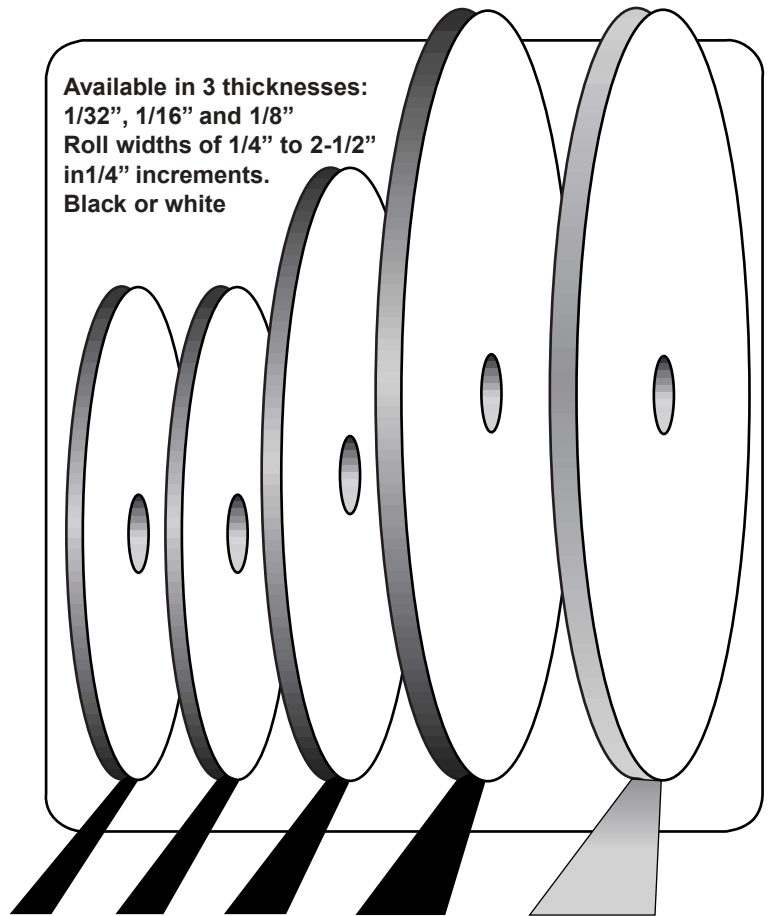

WHEN TO USE...	RUBBER	OR	ACRYLIC
Bifold Doors	X		
Shower Enclosures	X		
Beveled Overlays	X		X Acrylic allows for repositioning
Shims For Seam Reflection Lines	X		
High Temperature (Environment over 100°F. continuous)			X



**GUNTHER  
MIRROR & MORE CLEANER™**

A Superior Glass and Mirror All-purpose Cleaner

- **TESTED AND APPROVED FOR MIRRORS.** A superior mirror and glass all-purpose cleaner. Discover the wonders of this ammonia and vinegar free cleaner. Dissolves dirt, grease and most deposits. Leaves no film and cleans streak-free. Cleans glass, porcelain, tile, chrome, stainless steel, marble and appliances sparkling clean. You'll find it very useful for most cleaning jobs.
- **UNIQUE 5-GALLON BAG-IN-A-BOX DISPOSABLE CONTAINER.** Economical bulk container. Stackable, convenient to ship, takes less storage space than other containers and is easy to handle.

**STAINLESS STEEL MOULDINGS**

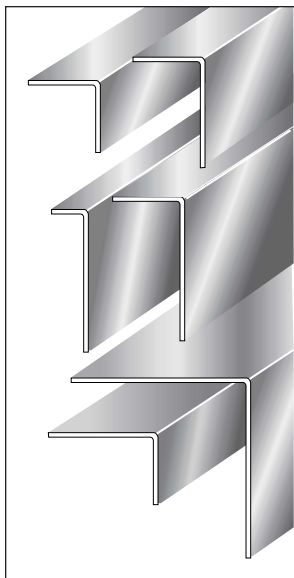

**MISCELLANEOUS PLAIN ANGLES**

Here are miscellaneous angles for a multitude of uses. In addition to those listed, we can furnish angles with a maximum dimensions up to 1 1/2" x 1 1/2" and in thicknesses up to .083 with our standard roller dies. Stock lengths, 8 ft.

*\*Non Stock. Special order 100 pc. minimum.*

SECTION NO.	GAUGE	SIZE
4760	.020	1/2" x 1/2"
*4761	.020	1/2" x 1"
*4765	.020	1/2" x 3/4"
4780	.023	3/4" x 3/4"
*4781	.023	3/4" x 1"
*4790	.023	7/8" x 7/8"
4795	.023	1" x 1"
*4796	.023	1/4" x 1"
*4800	.023	3/4" x 1-1/2"
*4801	.023	1-1/4" x 1-1/4"

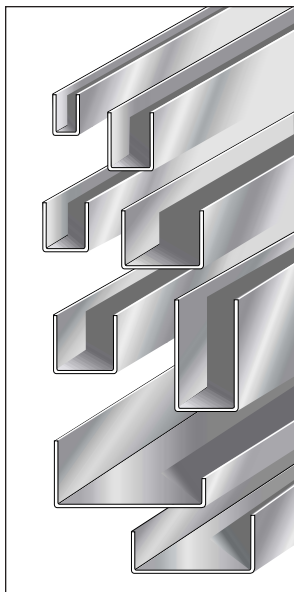

**PLAIN CHANNELS**

These channels can be used to fill a large variety of needs. In addition to the sizes listed, we have numerous other sizes and are prepared to fabricate any channels you may require. Stock lengths, 6 ft. Not punched.

*\*Available on minimum order of 100 pieces.*

SECTION NO.	GAUGE	LEG	SIZE INSIDE		LEG
			CLOSED END		
*4001	.015	1/4"	x	1/8"	1/4"
*4003	.015	13/32"	x	1/4"	13/32"
4010	.015	5/16"	x	1/4"	5/16"
*4013	.023	7/8"	x	9/32"	7/8"
*4015	.020	5/16"	x	3/8"	5/16"
4025	.018	5/16"	x	1/2"	5/16"
*4029	.020	3/8"	x	27/32"	3/8"
*4030	.020	3/16"	x	1"	7/16"
*4033	.020	3/8"	x	23/32"	5/16"
*4034	.020	3/8"	x	13/16"	3/8"
*4035	.020	*1/4"	x	13/16"	1/2"
*4060	.023	1/4"	x	1-29/64"	1/2"
4096	.020	3/8"	x	3/4"	3/8"
*4023	.023	3/4"	x	3/8"	3/4"

**\* Non-Stock Specials.**

**Available on Minimum Order Only.**



**INDUSTRIAL METALS**

**ITEM# Description Finish LGTH PCK WT**

**DIE 0439\***

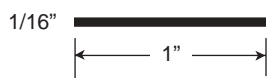

306321 Flatbar 1" x 1/16" EA 12' 6 8

**DIE 1005**



300030 Flatbar 1/2" x 1/8" (A-811) EA 12' 6 8

**DIE 1048**



300220 Flatbar 3/4" x 1/8" (A-812) EA 12' 6 9

**DIE 1004**



300020 Flatbar 1" x 1/8" (A-808) EA 12' 6 14

**DIE 1068\***



300306 Flatbar 1 1/4" x 1/8" EA 12' 6 15

**DIE 1049**



300228 Flatbar 1 1/2" x 1/8" (A-796) EA 12' 6 18

**\* Non-Stock Specials. Available on Minimum Order Only.**

**See Sections Listed Above with the Minimum Amount Required**



**INDUSTRIAL METALS**

	<b>ITEM#</b>	<b>Description</b>	<b>Finish</b>	<b>LGTH</b>	<b>PCK</b>	<b>WT</b>
<p><b>DIE 1285</b></p>	300895	Channel 5/16" x 3/8" (A-236)	EA	12'	6	6
<p><b>DIE 1362*</b></p>	301201	Channel 5/16" x 1/2"	EA	12'	6	11
<p><b>DIE 2161</b></p>	303751	Channel 5/16" x 3/4" (A-734)	EA	12'	6	12
<p><b>DIE 1347</b></p>	301151	Channel 7/16" x 1/4" (A-235)	EA	12'	6	10
<p><b>DIE 1346</b></p>	301143	Channel 9/16" x 1/2" (A-244)	EA	12'	6	10
<p><b>DIE 2223*</b></p>	304001	Channel 13/16" x 1/4"	EA	12'	6	10
<p><b>DIE 1038*</b></p>	300178	Channel 1/2" x 5/16"	EA	12'	6	12

**\* Non-Stock Specials. Available on Minimum Order Only.  
See Sections Listed Above with the Minimum Amount Required**



**INDUSTRIAL METALS**

**ITEM#      Description      Finish      LGTH    PCK    WT**

**DIE 1\$( \$\***

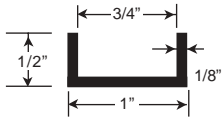

300187      Channel 1/2" x 3/4"      EA      12'    6    20

**DIE 1538\***

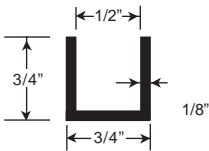

301901      Channel 3/4" x 1/2"      EA      12'    6    22

**DIE 1710\***

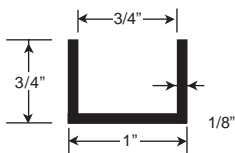

302501      Channel 3/4" x 3/4"      EA      12'    6    26

**DIE 1041\***

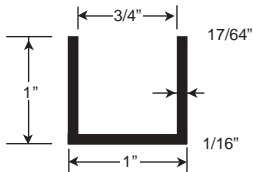

300191      Channel 1" x 3/4"      EA      12'    6    32

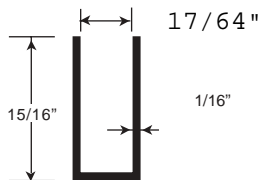

A-237 \*      Channel 7/8" x 17/64"      EA      12'    6

**\* Non-Stock Specials. Available on Minimum Order Only.**

**See Sections Listed Above with the Minimum Amount Required**



**INDUSTRIAL METALS**

	<i>ITEM#</i>	<i>Description</i>	<i>Finish</i>	<i>LGTH</i>	<i>PCK</i>	<i>WT</i>
<p><b>DIE 1225*</b></p>	300651	Angle 3/4" x 1/2"	EA	12'	6	6
<p><b>DIE 1750*</b></p>	302651	Angle 3/4" x 3/8"	EA	12'	6	10
<p><b>DIE 1033*</b></p>	300158	Angle 1" x 1/2"	EA	12'	6	12
<p><b>DIE 1249*</b></p>	300751	Angle 2 1/8" x 1"	EA	12'	6	34
<p><b>DIE 0141</b></p>	306001	Equal Angle 1/2" x 1/2" (A-103)	EA	12'	6	6

**\* Non-Stock Specials. Available on Minimum Order Only.  
See Sections Listed Above with the Minimum Amount Required**



**INDUSTRIAL METALS**

	<b>DIE 0151</b>	<b>ITEM#</b>	<b>Description</b>	<b>Finish</b>	<b>LGTH</b>	<b>PCK</b>	<b>WT</b>
		306051	Equal Angle 3/4" x 3/4" (A-803)	EA	12'	6	8
		306101	Equal Angle 1" x 1" (A-903)	EA	12'	6	12
		300083	Equal Angle 3/4" x 3/4" (A-1185)	EA	12'	6	16
		300091	Equal Angle 1" x 1" (A-1187)	EA	12'	6	22
		300110	Equal Angle 1 1/2" x 1 1/2" (A-1163)	EA	12'	6	32
		300450	Equal Angle 2" x 2" (A-1202)	EA	12'	6	44



**INDUSTRIAL METALS**

**ITEM# Description Finish LGTH PCK WT**

**DIE 2724\***

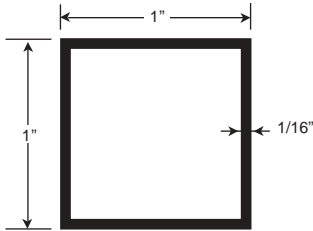

305012-This item has been discontinued

**DIE 1447\***

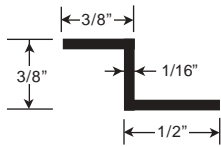

331350 Z Bar 3/8" x 1/2" x 3/8" MF 12' 12 18

**DIE 0569\***

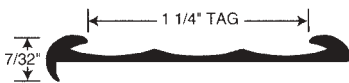

331940 Conventional Molding 1 1/4" tag BA 12' 12 20

**DIE 1356\***

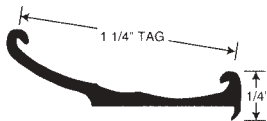

331260 Standard Concave Molding 1 1/4" tag x 1/4" BA 12' 12 23